

Keysight Technologies

Recommendations for Testing High-Power Amplifiers Using the PNA Microwave Network Analyzers

Application Note

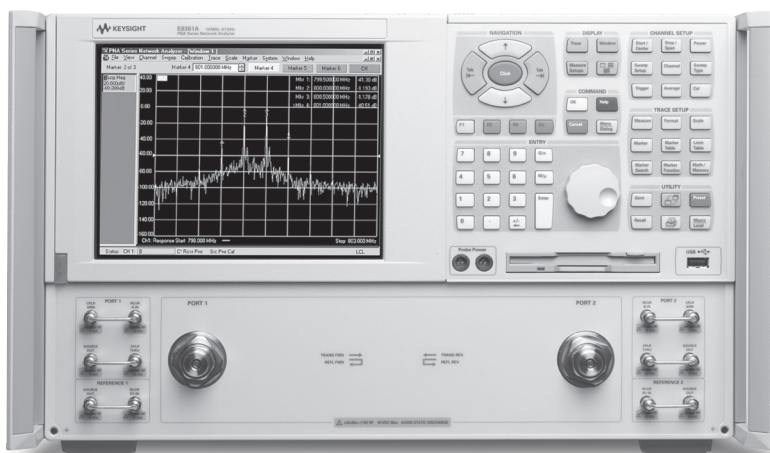

Table of Contents

Introduction	2
Power Budget Analysis and MW PNA Block Diagram.....	3
Example A: Dual-band handset amplifier for GSM900 and DCS1800	5
Example B: Ku-Band solid state power amplifier	8
Step-by-Step Guide for Measuring a High Power Amplifier.....	10
Step A: S-parameters, low-power level test, low-power setup.....	11
Step B: S-parameters, low-power level test, high-power setup	15
Step C: Gain compression test, high-power setup.....	22
Alternative High-Power Configurations.....	24
Use of external coupler	24
Two-way high-power measurements	25
FAQ	26
1. How do I know if the network analyzer receivers are compressed?.....	26
2. The uncalibrated results seem reasonable, but the calibrated data appears incorrect. What could be the cause?.....	27
3. What is the power of the network analyzer at start-up or preset?.....	27
4. What is the power level of different measurement channels at preset?	27
5. Can different measurement channels have different power levels?.....	28
6. Can I use this setup to make hot S_{22} measurements?	28
7. What happens to the power level when RF power is turned off during a sweep?	28
8. Is there a power limitation on the mechanical components of a calibration kit?	28
9. Is there a power limitation on electronic calibration or ECal?.....	28
10. What are the benefits of a source-power calibration?.....	29
11. What is the optimum power level for calibration?	29
12. What happens to the power level at each port during various measurements?	30
13. What happens to the two-port calibration if the source or receiver attenuation is changed?.....	30
14. What does the error message "source unlevelled" signify?.....	30
15. What happens to the PNA output power during re-trace?.....	30
16. What happens to the RF power during frequency band-crossings?.....	31
Appendix A: Maximum Power Levels for PNA and PNA-L Network Analyzers.....	32
Appendix B: Understanding PNA measurements with an external reference signal and source attenuator changes.....	40
Recommendations for High Power Measurements.....	47
Web Resources	47

Introduction

High-power amplifiers are a common building block of RF and microwave communication systems. Mobile phones, used by millions of users, contain high-power amplifier chips. Satellite systems and base-stations used for transmitting data depend on multitude of solid-state or traveling wave tube power amplifiers. Characterizing the performance of high-power amplifiers is a critical factor in the design and verification process.

This application note discusses the unique challenges involved in testing high-power amplifiers using Keysight Technologies, Inc. microwave (MW) PNA network analyzers. Keysight application note, publication number 5966-3319EN, covers configurations and concerns of testing high-power devices using network analyzers in general. For information on common amplifier tests (not unique to high-power), Keysight offers three complementary application notes. Publication numbers 5988-8644EN, 5988-9473EN and 5988-9474EN describe linear amplifier, gain compression, swept-harmonics and intermodulation distortion measurements.

In this application note, the term high-power refers to the cases where the output power of the MW PNA is not sufficiently high enough to measure the performance of the device under test (DUT), or the output power of the DUT exceeds the maximum input level to the network analyzer.

Power Budget Analysis and MW PNA Block Diagram

One of the main factors to consider in a high-power network analyzer measurement is the power-handling capability of the internal components of the network analyzer. High power levels can damage the network analyzer, and it is costly to repair the internal components of the network analyzer. In addition to damage level, compression level and noise levels also have to be considered in a high-power setup. The initial step in a high-power measurement is calculation of the power-budget or a power-flow analysis. In this section, we examine the block diagram of a PNA network analyzer, followed by two examples of power-flow analysis.

Figure 1 shows the block diagram of the 20 GHz E8362B¹ MW PNA network analyzer. Table 1 lists the damage level for the components of the 20/40/50 GHz E8362/3/4B PNA. Damage and compression power levels for the 67 GHz E8361A PNA can be found in the Appendix. In general, we recommend that components not be operated near damage level and the power level be kept at least 3 dB (preferably 6 dB) below damage level. The user should be aware that optimal level could be well below damage level, as is the case with the receivers.

A copy of this diagram (in Microsoft Visio file format) is available to download on the Keysight web site. Visit: <http://www.keysight.com/find/pna>, go the “Library” section and select “Manuals & Guides”. The electronic version of this block diagram can be used to perform power flow analysis for your particular test setup.

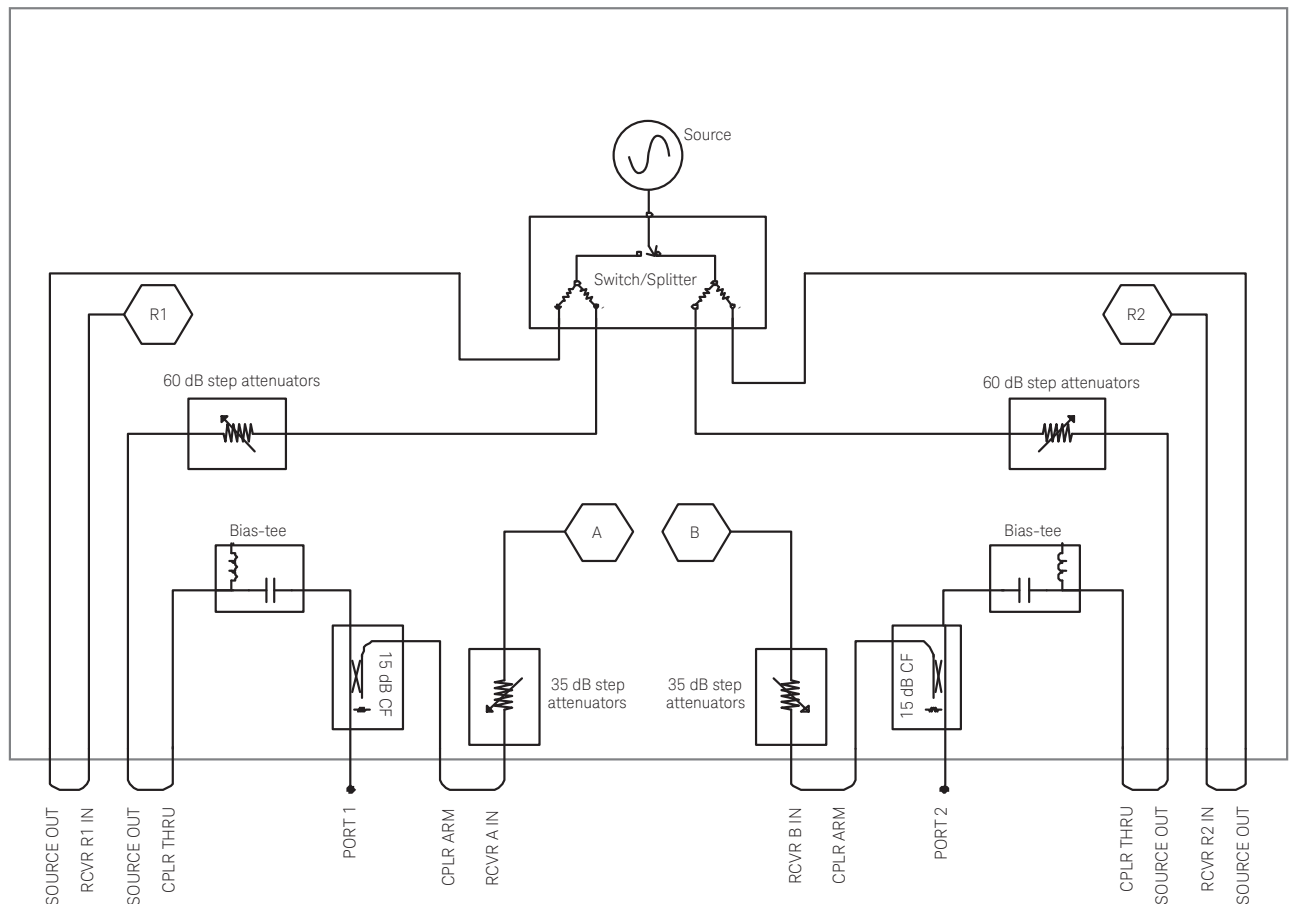

Figure 1. MW PNA E8362B block diagram, configured with source attenuators, receiver attenuators, bias-tees, and frequency-offset mode. (Options 016, UNL, 014, 080)

1. E8362B configured with options 014 (configurable test set), option UNL (source attenuators and bias-tees) and option 016 (receiver attenuators)

Table 1. MW PNA E8362/3/4B power level information

Component	Damage level	Notes
Switch/splitter	+ 30 dBm	The switch/splitter assembly is one of the most sensitive components of the network analyzer. Be very careful not to damage it with high power levels. Signal levels over +30 dBm will damage this microcircuit. ¹
Test port 1 or 2	+ 30 dBm	The optimum power level at the test port is less than 0 dBm. Compression level at the test port: <0.1 dB at -5 dBm <0.45 dB at +5 dBm.
Receivers R1,R2,A,B	+ 15 dBm	Optimum power level at receivers (mixers) is -20 dBm or less.
Bias-tees	+ 30 dBm	The bias-tees can be the dominant power limiting component of the MW PNA. Keysight provides a high-power test set that has the bias-tees eliminated (Option H85).
60 dB source attenuators	+ 30 dBm	-
35 dB source attenuators	+ 30 dBm	-
Couplers	+ 43 dBm < 20 GHz + 40 dBm > 20 GHz	The coupling factor is approximately 15 dB, above 600 MHz. Below 600 MHz, the coupling factor increases with decreasing frequency at a 20 dB/decade rate. ²

Why is the damage level listed at the test port +30 dBm, but +43 dBm for the coupler? Isn't the coupler located right at the test port?

Yes. The coupler is right at the test port, but while the coupler can handle up to +43 dBm (<20 GHz), the bias-tees (which are located immediately after the coupler) have a damage level of +30 dBm. Therefore if more than +30 dBm is applied to the test port, the bias-tees will be damaged. The receiver attenuators also have a +30 dBm damage level, but they can be protected with attenuation placed between the CPLR ARM and RCVR A IN jumpers. There is no jumper between the coupler and the bias-tee, so there is no way for a user to decrease the power between the coupler and the bias-tee. Thus the power at the test port should be limited to less than +30 dBm. If you want to take advantage of the high-power capabilities of the coupler, there are two options. One is to purchase an instrument without the bias-tees (and source attenuator, which is coupled with the bias-tees under option UNL). The second alternative is Keysight's special MW PNA, E836x-H85. Special Option H85 adds the source attenuators, but not the bias-tees.

1. The high power switch on the Keysight 8720 network analyzer Option 085 was a mechanical switch and could handle higher power levels. On the PNA, it is an electrical switch and therefore susceptible to damage at high power levels.
2. The same couplers are used in Keysight E8362/3/4B, E8362/3/4/B Option H85 or 8720/22ES Option 085.

MW PNA Example Configurations for Testing High-Power Amplifiers

Example A: Dual-band handset amplifier for GSM900 and DCS1800

This is an example of dual-band handset amplifier, used in mobile communications. The specifications for this amplifier are listed in the table below. Figure 2 shows a configuration that can be used to test this handset amplifier.

Frequency range	880 to 915 MHz and 1710 to 1785 MHz
Input power range	0-3 dBm
Output power	32-35 dBm (~3 watts).
Input VSWR	1.5:1
Isolation	40 dB
2nd Harmonic distortion	-40 dBc
3rd Harmonic distortion	-40 dBc
AM-PM conversion	20 degrees/dB (Pout: 34 to 35 dBm)

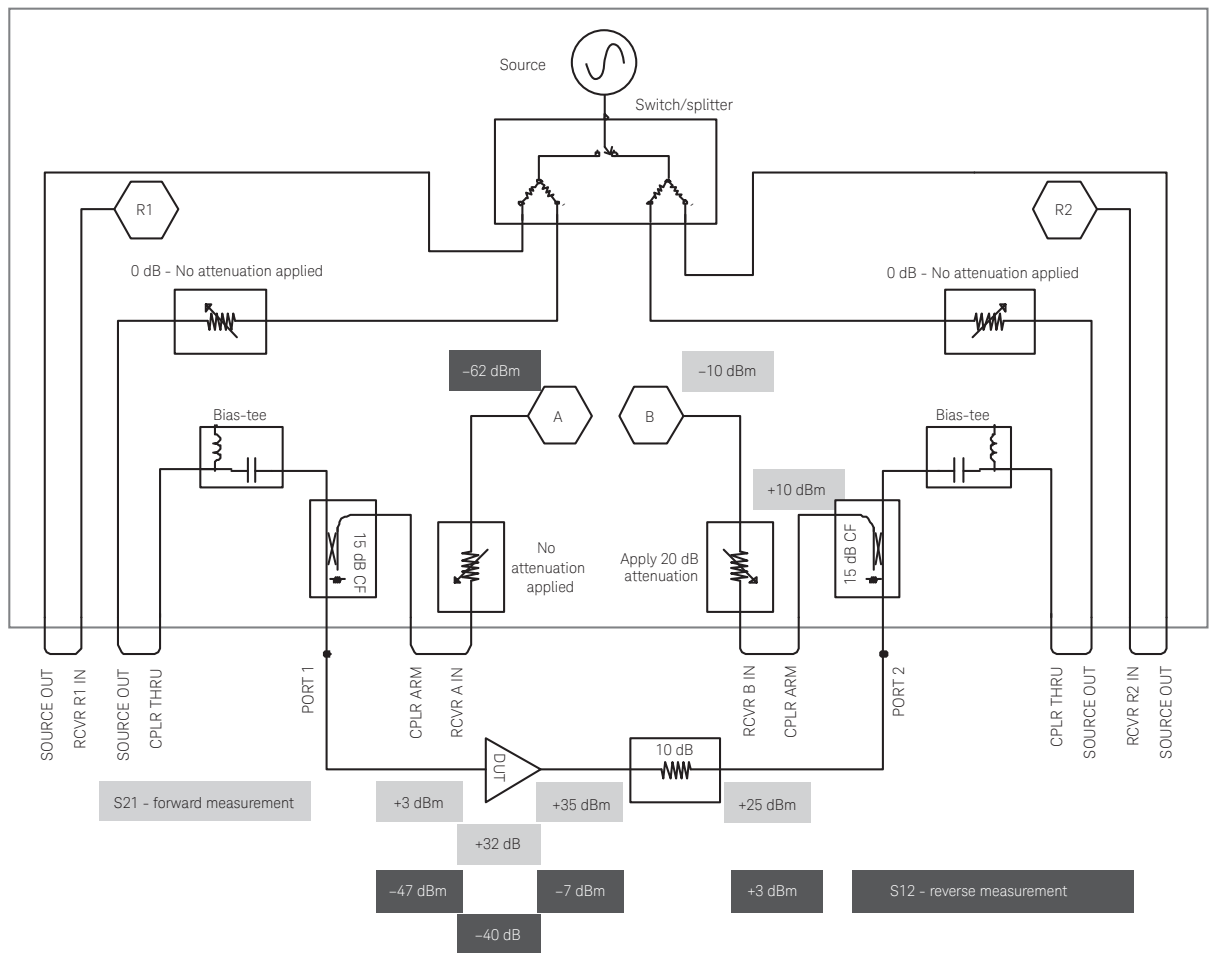

Figure 2. MW PNA E8362B, configured to measure a dual-band handset amplifier

Note

The +30 dBm limitation is not due to the couplers, because the couplers can handle up to +43 dBm at 2 GHz. The limitation is due to the bias-tee which has a maximum rating of +30 dBm.

The input power range for this device is 0-3 dBm, at 2 GHz. The E8362B has a maximum output power of 3 dBm, so we can directly drive the amplifier using the MW PNA. However, the output level of +35 dBm exceeds the +30 dBm damage level of the PNA. In this configuration, we use an external 10 dB attenuator to protect the PNA receivers, bias-tee and switch/splitter assembly

Note

In high-power measurement, you should consider power levels during both measurement and calibration with the different standards.

Let's examine the power-flow in the forward direction, with maximum input power to the DUT of +3 dBm. The input VSWR is specified at 1.5:1 (14 dB return loss), so we can assume that the reflected signal will be approximately -11 dBm. (3 dBm incident -14 dB return loss = -11 dBm upon the test port). -11 dBm will not damage the bias-tees or switch/splitter assembly. The -11 dBm will also be reduced by the 15 dB coupling factor and the A receiver will see about -26 dBm of power, which is acceptable. During calibration, when the open or short are connected and all the +3 dBm is reflected back, power levels are still acceptable. (3 dBm incident - 0 dB return loss = 3 dBm upon the test port)

Note

Consider the power handling capability of the external components.

Now let's examine the output of the DUT at this point and the S_{22} measurement. With an input of 3 dBm, we can expect an output power level of approximately +35 dBm, which will damage the port 2 bias-tee. We add a 10 dB external attenuator to the amplifier to protect the bias-tees and reduce the power incident upon the bias-tee to +25 dBm, 5 dB below damage level. This attenuator also ensures that we do not damage the transfer switch. Be sure to select an attenuator that can handle your power level. The Keysight 8491 series attenuators have a maximum average power rating of 2 watts. Keysight 8498A can handle up to 25 watts average power and is specified to 18 GHz.

Note

Attenuation before the coupler input degrades uncorrected directivity by twice the attenuation amount.

While more attenuation will move the power level further away from damage level, it does degrade the port 2 uncorrected directivity. Therefore, we should add the least amount of attenuation that we need. The switch/splitter can handle the +25 dBm also; damage level is +30 dBm. If the bias-tee were not present in the system, we could add the external attenuation after the coupler (between the CPLR ARM and RCVR B IN jumpers) and not degrade the directivity. We could also use PNA's receiver attenuators. This would require adding 10 dB external attenuation between CPLR THRU and SOURCE OUT (on the port 2 side) to protect the source attenuators. (See Figure 3 for alternative configuration)

With an output power of +35 dBm, 10 dB of external attenuation and 15 dB of coupling factor, the B receiver will see +10 dBm of power, which is below the +15 dBm damage level. However, the B receiver will be compressed with +10 dBm. So we recommend using 30 dB of receiver attenuation to reduce the power incident upon the B channel receiver to -20 dBm.

Note

Make sure receivers are not operating in the noise. If the power incident upon receivers is low, reduce the IFBW or use averaging to decrease the PNA noise level.

During the S_{22} measurement, the source power incident upon the output of the amplifier will be approximately -7 dBm (3 dBm source power, 10 dB attenuation). If we assume a 10 dB output return loss, we will measure -62 dBm at the B receiver, which is above the noise floor of the network analyzer. To measure a -62 dBm signal, we need to reduce the IFBW. The selected IFBW depends on what the user considers an acceptable amount of noise. Narrowing the IFBW decreases the noise level, at the cost of measurement speed.

Note

If you are using a two-port calibration, it is important that you pay attention to the accuracy of all four S-parameters. Even if you are not measuring the S_{12} or S_{22} , a two-port cal uses all four S-parameters. So, it is critical to make sure that all four S-parameters are accurate.

Let's examine the S_{12} measurement. The power incident upon the output port of the amplifier is approximately -7 dBm. With an isolation of 40 dB, 15 dB coupling factor, we can expect -62 dBm at the A receiver, which is well above the noise level.

Figure 3 shows the same measurement, using the MW PNA Option H85 configuration. In this case, the bias-tees are removed, thus eliminating the need for external attenuation before the coupler.

The input is the same as described in the previous section for Figure 2. The output is +35 dBm; the couplers can handle up to +43 dBm, so we do not need to protect them. We do need to protect the B receiver, so we use 10 dB of external attenuation and 30 dB of internal attenuation.

The external attenuator is added between the PORT 2 CPLR ARM and RCVR B IN. Compare it to Figure 2, where the attenuator is added before port 2. Attenuation added after the coupling arm, does not degrade the directivity. Also, we need to add an attenuator/isolator before the transfer switch and source attenuators, since +35 dBm is higher than the +30 dBm specified damage level. An isolator is preferable because it does not reduce the output power available at port 2, as much as an attenuator would. The isolator must be able to handle the high power levels and cover the frequency range of test.

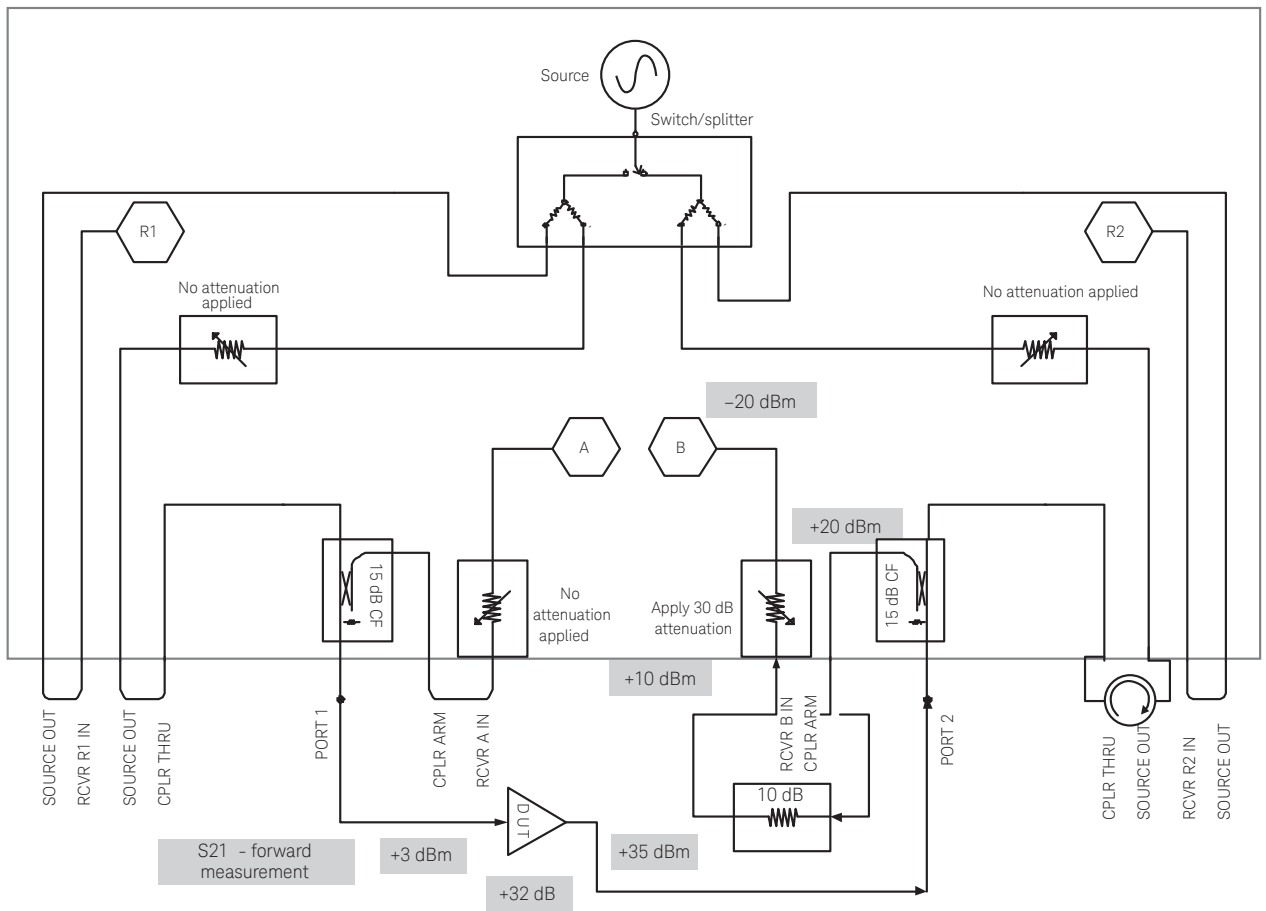

Figure 3. MW PNA E8362B-H85, configured to measure a dual band handset amplifier

Note

We need high-power measurement only in the forward direction and are satisfied with standard measurements in the reverse direction. If you need high-power measurements in both directions, refer to Figure 14.

Note

The position of the pre-amplifier and external directional couplers allows us to ratio out any drift due to the pre-amplifier. If the pre-amplifier was positioned directly outside of port 1 (connected to port 1 output), the drift would have resulted in measurement error. Also, with this configuration, all four S-parameters can be measured, whereas if the pre-amplifier is directly connected to port 1, the S_{11} and S_{12} parameters of the DUT cannot be measured.

The maximum power of a fully loaded (with options) MW PNA at 17 GHz is 0 dBm. Our amplifier under test requires an input power of +35 dBm. So, we need to add a pre-amplifier capable of putting out +36 or +37 dBm, so that after the loss of the througharm of the coupler and cables, we have +35 dBm at the DUT input.

We add a pre-amplifier to the output of the port 1 SOURCE OUT. The main arm of the external coupler is connected to the CPLR THRU jumper of port 1 and the coupled arm is fed back into the reference R1 receiver. The receivers' damage level is +15 dBm and optimum value is -20 dBm. Let's assume a 20 dB coupler. We need to add at least 10 dB of attenuation to prevent damage to the receiver. We add a 36 dB attenuator to the output of the coupled arm to reduce the power at the receiver to a level below compression.

The port 1 coupler will see +35 dBm, which it can handle. The test port couplers' damage level is +43 dBm. If the signal is fully reflected, we will have a +20 dBm incident upon the receiver attenuators. Without any internal receiver attenuation, the receivers will see +20 dBm, which is above their damage level of +15 dBm. For extra precaution, we add 10 dB of attenuation between the CPLR ARM and RCVR A IN. Then we apply 30 dB of internal PNA receiver attenuation to bring the power level at the A receiver to -20 dBm.

Now let's look at the through connection or S_{21} . An output power level of +50 dBm (100 watts) would damage the PNA test port couplers, so it is essential to add attenuation to the output, either via a coupler or high-power attenuator. We need to reduce the power level so it's less than the damage level of +43 dBm (20 watts). We can use a coupler and terminate the through port in a high power load. The coupled arm can be fed into the CPLR THRU of port 2.

Without any receiver attenuation, the receivers will see +15 dBm, which is their damage level. So we add 10 dB of external attenuation between the CPLR ARM and RCVR B IN jumpers to protect them. Next we apply 25 dB of receiver attenuation to reduce the power level at the B receiver to -20 dBm.

The +30 dBm of power incident upon port 2 will go through the coupler and is incident upon the source attenuator and switch/splitter leveler. This power level is just at the damage level of the source attenuators and especially the switch/splitter assembly, therefore we need to add a high power isolator between CPLR THRU and SOURCE OUT of port 2. Thus, when the amplifier is driven in the forward direction, the source attenuator and switch/splitter assembly are not damaged.

Step-by-Step Guide for Measuring a High Power Amplifier

This section describes in detail the necessary steps to measure a high power amplifier. The amplifier used here is based on the Motorola IC MHPA21010, an RF high power LDMOS amplifier. The specifications applicable to this example are listed in the table below. To test this amplifier, we will use an E8364B network analyzer, loaded with configurable test set, source attenuator, receiver attenuator, bias-tees, and frequency offset mode.

DUT Performance - RF high power LDMOS amplifier	
Rating	Value
Frequency range	2110-2170 MHz
RF input power (single carrier CW)	+20 dBm
Power gain (f = 2140 MHz)	23.7 dB minimum, 25 dB typical
Gain flatness	0.2 dB typical, 0.6 dB maximum
Power output @ 1 dB compression (f = 2140 MHz)	41.5 dBm
Input VSWR (f = 2110-2170 MHz)	1.5:1 typical, maximum 2:1

The goal here is to measure the linear S-parameters and gain compression. The linear S-parameters can be tested easily under low-power conditions. The gain compression test requires that the DUT be driven with high-power levels, thus requiring a pre-amplifier. The setup and calibration with the pre-amplifier is more complicated and it is easy to make mistakes. We recommend a procedure to verify the performance of the setup. The procedure consists of testing the S-parameters with the pre-amplifier setup, but with the power levels set to low levels (similar to the levels without the pre-amplifier), and then comparing the results to our initial linear S-parameters. If the values compare within a reasonable range, then we can have confidence in our high-power setup and proceed with the gain compression measurement. This process is described in the following three steps.

Measurement Steps

Step A	S-parameters, low-power levels, low-power setup	Measuring the S-parameters under standard (non high-power) operating conditions. Do not need pre-amplifier on input. Use attenuator on output. See Figure 5.
Step B	S-parameters, low-power levels, high-power setup	Use pre-amplifier on input and attenuators on output. Set power levels such that the power incident upon the device is similar to step A. See Figure 8.
Step C	Gain compression, high-power, high-power setup	Use pre-amplifier on input and attenuators on output. Test amplifier under power sweep conditions. See Figure 11.

Step A. S-parameters, low-power level test, low-power setup

The block diagram used for this procedure is shown in Figure 5. The first step is to perform a power-flow analysis. With an input power of -10 dBm and gain of 26 dB, we can expect an output power of $+16$ dBm. While $+16$ dBm will not damage the bias-tees or receiver attenuators, we will choose to add a 6 dB attenuator. The reason is that the PNA has a maximum output power of $+3$ dBm and if we accidentally increase the power level (with a gain of 26 dB) we can reach $+29$ dBm, which is near the damage level of the PNA components. Therefore, adding a 6 dB attenuator, we are reducing the chance of the PNA being damaged.

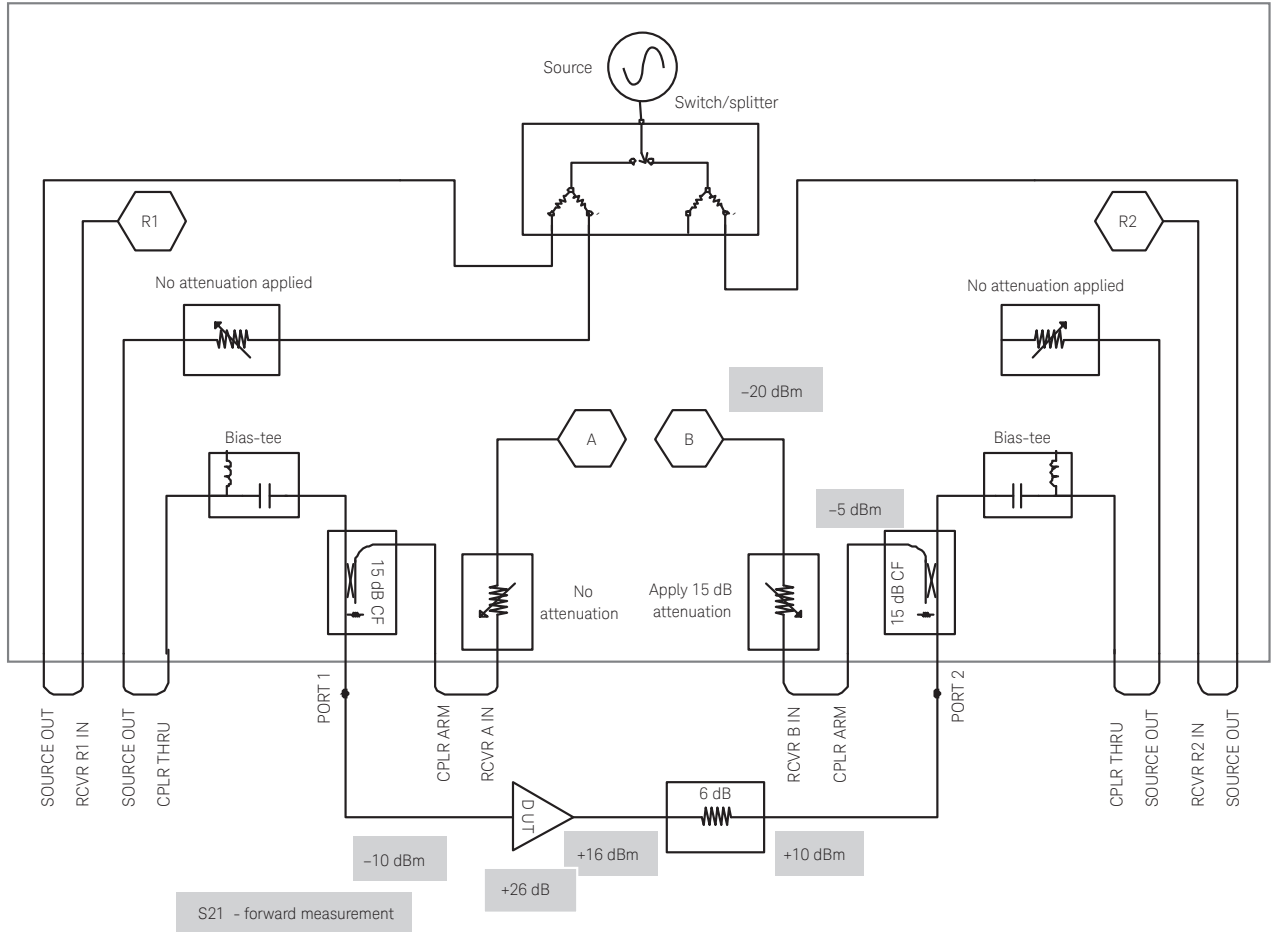

Figure 5. MW PNA E8364B for testing handset amplifier – low input power

Before performing a calibration, connect the amplifier and make sure that the power level and attenuator settings are at the desired levels. In order to prevent damage, the sequence below is generally recommended for connecting amplifiers.

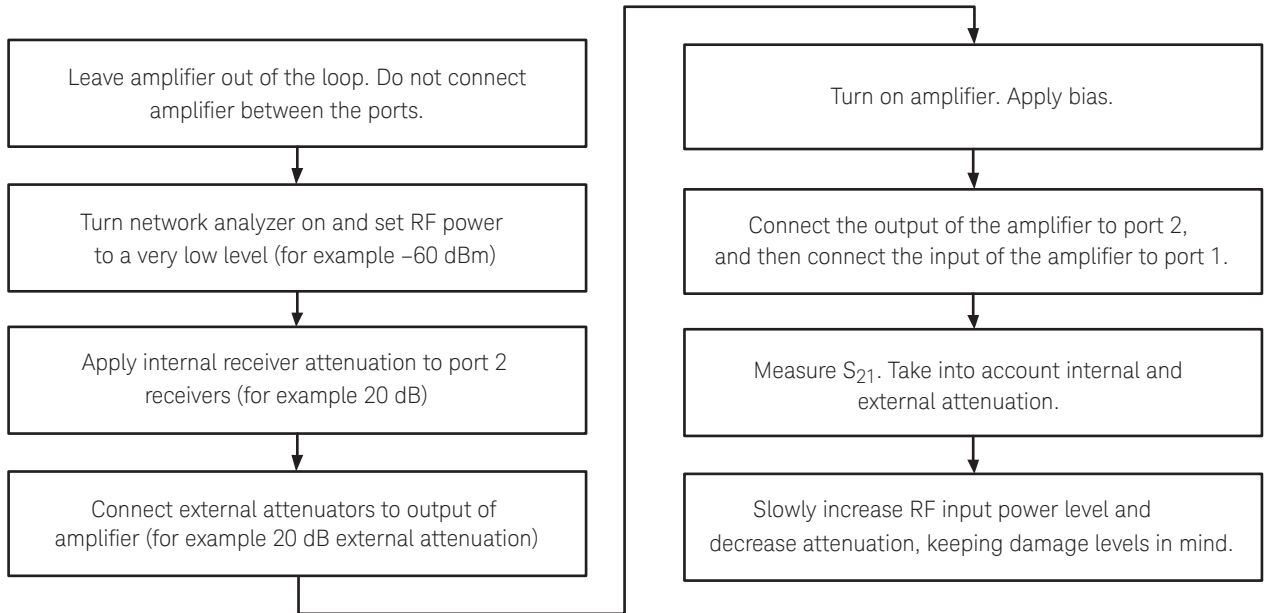

Figure 6. Procedure and sequence to connect amplifier to network analyzer

[Preset]

Set the start and stop frequency

[Power] > Level > -60 dBm

[Measure] S₂₁

Turn amplifier on.

Set the power level on the PNA to a very low value before applying biasing to the amplifier. It is better to use a low RF power level versus having *RF power off*. If you turn *RF power off*, you may not know where the power level will be when you turn it on; however, if the power is set to a low level, you will know the output power of the network analyzer. In this example, we start with the power set to -60 dBm. Then we look at the S_{21} of the amplifier. The S_{21} may appear lower than the expected value. This is because we have an external attenuator that we have not calibrated out yet. In this case, we see a gain of about 20 dB instead of the 26 dB (6 dB loss in the attenuator). Once we perform a calibration, the attenuator loss will be removed.

We would like to measure the S-parameters of this amplifier with -10 dBm input power. With -10 dBm input, 26 dB gain, and 6 dB of attenuation, we will have $+10$ dBm incident upon the test port. We apply 15 dB of receiver attenuation, so that the PNA receivers are not operating in compression. You will notice that the gain or S_{21} drops by the amount of receiver attenuation. This is because we have an uncalibrated setup. The receiver attenuators can be accessed from the menu:

Channel > Power ...

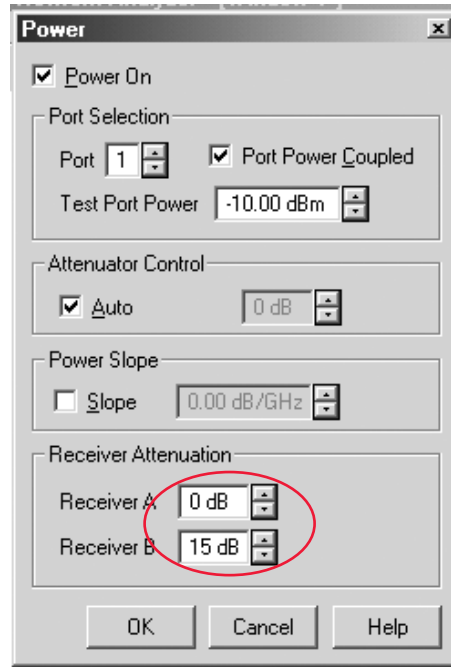

Slowly increase the power level and observe the gain; it should not change until you approach the compression of the amplifier under test. However, we cannot compress this amplifier with the power directly available from the PNA.

[Power] > Level > -10 dBm

Consider reducing the IFBW to decrease the noise level. You can examine the uncalibrated S-parameters (especially the S_{12}) with various IFBWs to determine the acceptable noise level for your measurement. In this example, we decrease the IFBW to 1 kHz.

[Sweep Setup] > Bandwidth > 1 kHz

Note

The source-power cal is **optional**, as the output power of the MW PNA is well leveled; the source-power cal simply increases measurement accuracy. The two-port calibration is **necessary**, as the effect of the attenuators (external and internal) must be removed in order to obtain correct S-parameters.

Now that we have a setup that works well, we can perform a calibration. Remove the amplifier under test. Perform a source-power calibration at the input point of the amplifier to ensure a constant and known power at the amplifier input. Next, perform a two-port calibration to remove the systematic errors and effects of the external and receiver attenuators. We use an Electronic Calibration Module (ECal) in this example – we simply connect the ECal module in place of the amplifier. You can also perform a source-power calibration on port 2, if the amplifier S_{12} and S_{22} are sensitive to small variations in input power.

Calibration > source-power cal ...

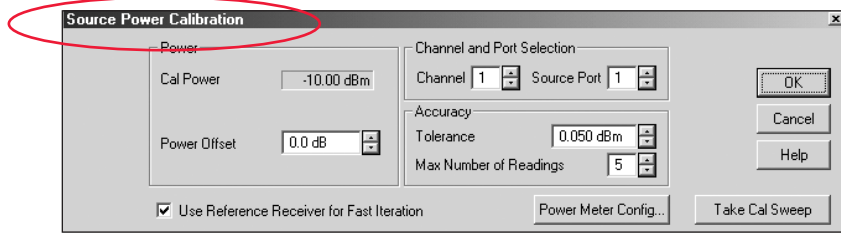

Calibration > Calibration Wizard

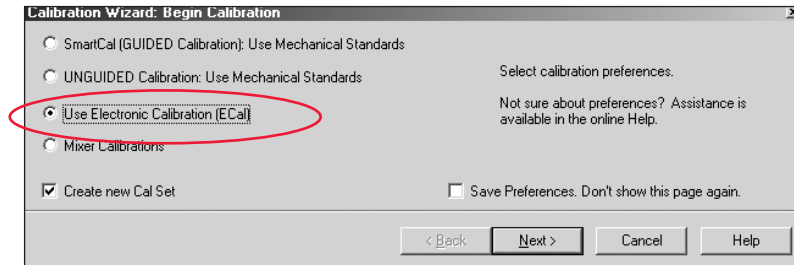

The following parameters are based on the S-parameters and can be verified. Figure 7 shows the measured S-parameters for this device.

- Gain, Gain Flatness
- Input VSWR or Return Loss
- Output VSWR or Return Loss
- Isolation (Not specified for this device, but is the same as S_{12})

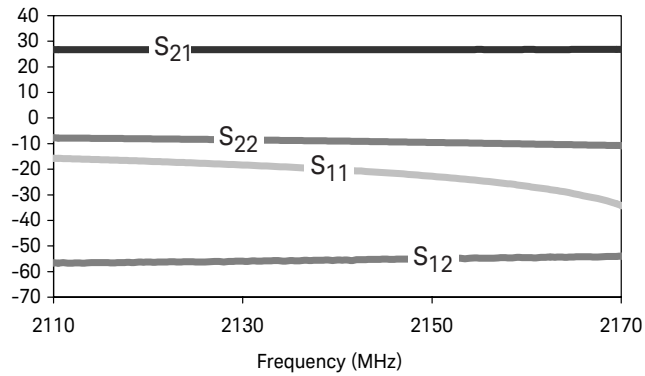

Figure 7. S-parameters of high-power amplifier, under low-power (linear) conditions

Step B: S-parameters, low-power level test, high-power setup

This section describes the procedure to test the S-parameters under low power levels, with a high-power setup. The high-power setup is necessary for gain compression test. The block diagram in Figure 8 shows the necessary test setup. Again, the purpose here is to verify the high-power setup. We will compare the test results of the low-power setup with low-power levels to the high-power setup with still low-power levels. If the results compare within a reasonable range, then we can have confidence in our high-power setup and use it to perform high-power measurements, such as gain compression. We are comparing the results of Step A and Step B.

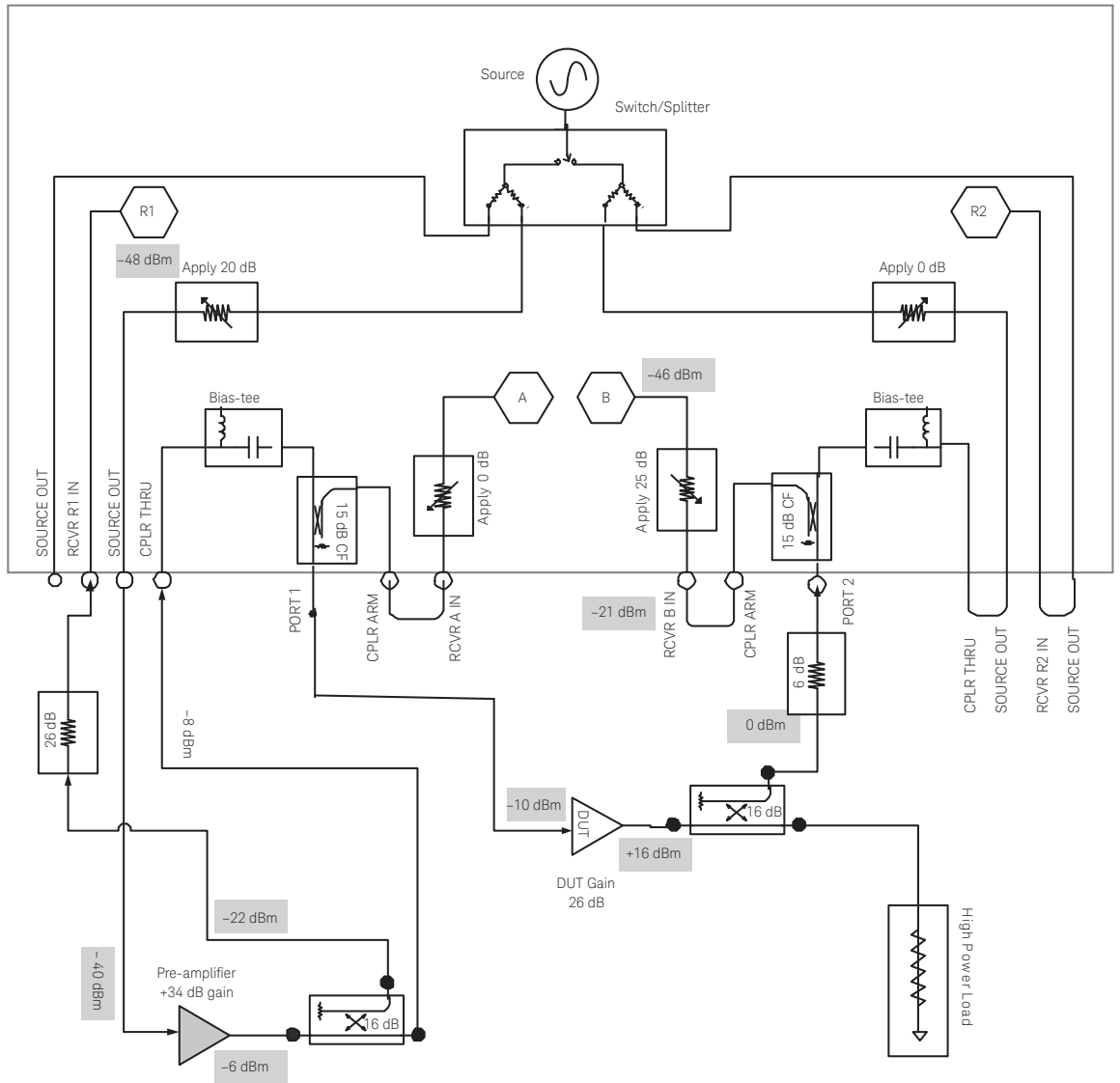

Figure 8. High-power setup, for low-power testing of S-parameters

Note

The external attenuators in this setup were chosen to accommodate the high-power measurement conditions (see Figure 11). So in the case of low-power measurements, they are not the ideal components. But because they are necessary for high-power measurements, we add them to the system.

Block Diagram Components

Pre-amplifier

The main criteria for the pre-amplifier is that it can produce enough power to drive the device under test. An amplifier with high isolation is desirable. Of course, the frequency range of the pre-amplifier should cover the range of the DUT. In this example, a Mini-Circuits amplifier, part number ZHL-42 is used. This amplifier operates from 700-4200 MHz (covering the frequency range of our DUT) and compresses at +28 dBm (sufficiently above our required test input power of +20 dBm). It has a typical gain of 33 dB, so in order to get our desired +20 dBm, we need an input of -12 dBm, which the PNA can easily supply.

Reference channel coupler

This coupler should be able to handle the output power of the pre-amplifier. The purpose of this coupler is to allow that part of the power to be coupled out to the reference receiver. For an S_{21} measurement, we need to compare the B and R1 receivers. So we need to measure the input power using the R1 receiver and thus, feed the amplifier input power to the R1 receiver. In this example, we use a Keysight internal PNA coupler, which can handle 30 dBm and has a 20 dB coupling factor.

A good method to test the power flow is to use a power meter to verify the power level at different points in the RF path. You connect one component, test the power level at the output, connect the next, check the power level on the output and keep verifying the power level at various points. If you are sweeping a wide frequency range, there will be some variations in the power level, but to a first degree, it will give you an idea of the power levels. You can test in CW mode or over a narrow frequency span initially to determine the various power levels. The goal here is to understand the power flow and to ensure that the network analyzer components will not be damaged.

Make sure the power sensor you are using can handle the high power levels. A power level of 999.99 on the power meter means that you have overloaded the power sensor and probably damaged the sensor. Keysight offers the following power sensors, for high-power measurements.

Note

At the time of the publication of this application note, the E9300 Series power sensors cannot be used with the PNA network analyzers. The reason is that the E9300 power sensors only work with the E4416/7 power meters, which are not supported by the PNA. We have plans to add the E4416/7 power meter drivers to the PNA firmware. Check the PNA support page to find out the status of this enhancement.

Power Sensor	Minimum power (dBm)	Maximum power (dBm)
8481B	0	+44
8481H	-10	+35
E9300B, E9301B	-30	+44
E9300H, E9301H	-50	+30

For more information on the 8480 Series and E-Series power sensors, visit www.keysight.com/find/powermeters

Set the frequency range and turn on frequency-offset mode, so that you do not need to use the reference channel input for phase-locking.

[Preset]

[Start/Center] > 2110 MHz

[Stop/Span] > 2170 MHz

[Sweep Setup] > Bandwidth > 1 kHz

[Sweep Setup] > Number of Points > 201

[Measure] > S₂₁

Menu item **Channel > Frequency-offset ...**

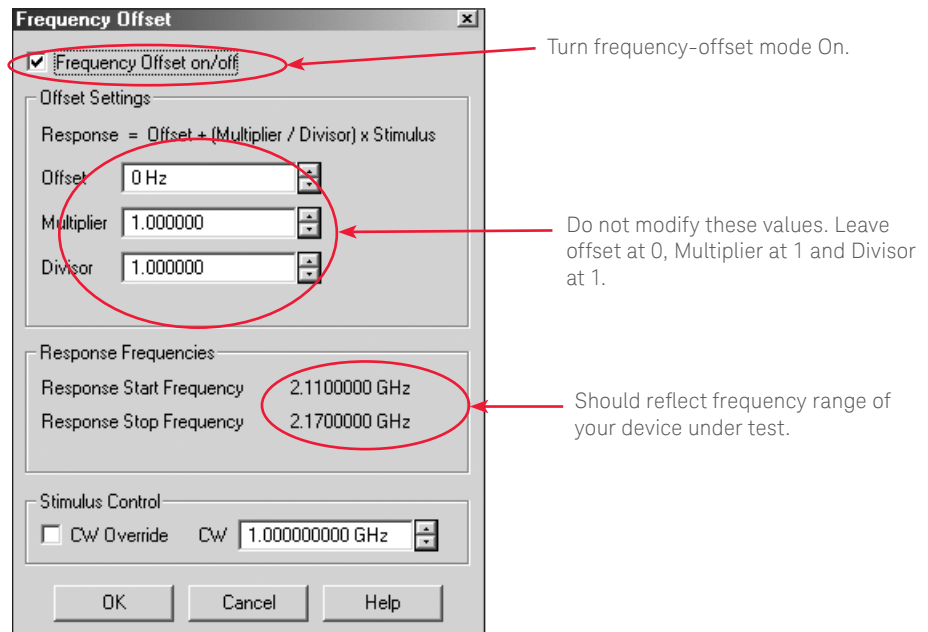

Note: Phase-lock lost and use of frequency-offset mode

In standard network analysis, the reference receiver (R1 for forward, R2 for reverse) is used for phase-locking between the RF source and receiver LO. The phase-locking requirement imposes signal clarity and power level restrictions on the reference channel signal. This makes the task of high-power measurements much more cumbersome, and users often have to deal with the “phase-lock lost” error message. With the PNA, users can bypass this issue by using the frequency-offset mode (Option 080). When the network analyzer is in frequency-offset mode, the R1 receiver is not used for phase locking; independent internal circuitry is used to phase lock the source and receivers.

We highly recommend that you turn on the frequency-offset mode, simply to take advantage of the independent phase locking mechanism (not to measure different source/receiver frequencies). Set the offset to zero, so that the source and receiver frequencies are the same.

If your PNA is not equipped with the frequency-offset mode option and you need to use the reference channel for phase-locking, the following are the requirements on the R-channel signal: Power level between -10 and 0 dBm and a clean signal, without spurious content.

Power level settings

Next, set the power levels and attenuator settings. Since a very low power level is required for port 1, uncouple port 1 and port 2 power levels. For port 2, we do not need a low power level and in fact, if we start with a low power level, attenuate it, and then measure the S_{12} isolation, the S_{12} measurement will be in the noise. Therefore, we want to uncouple the power levels and set the port 2 power to a higher level. PNA network analyzers have two separate source attenuators, one for port 1 and another one for port 2, so you have considerable control over varying the source power levels.

Menu item **Channel > Power ...**

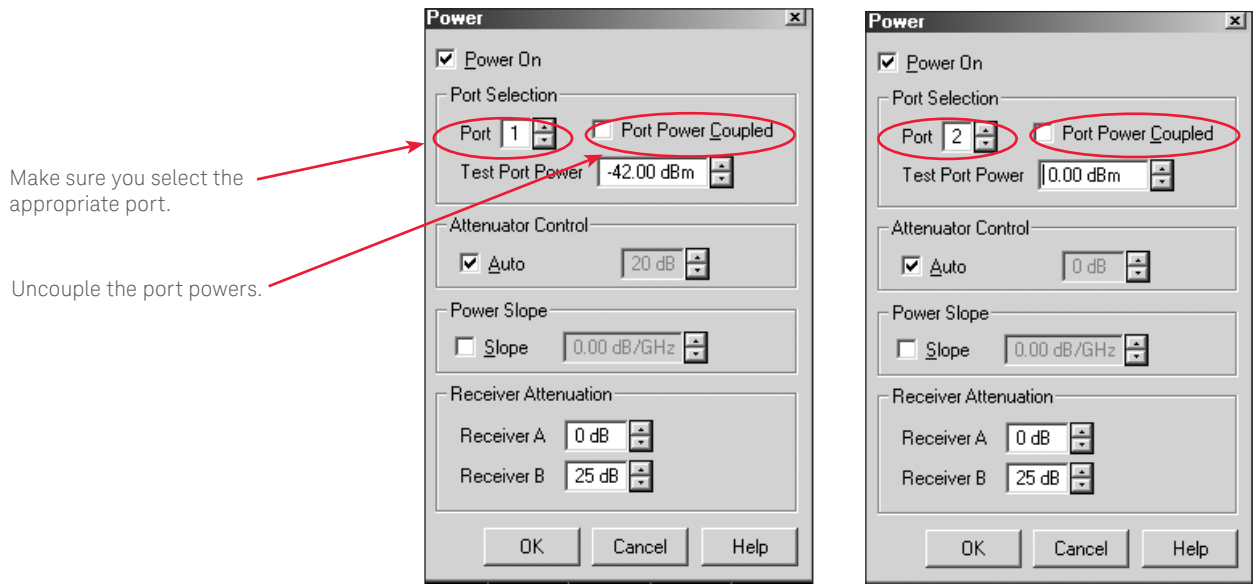

In order to determine the power levels at each port, go through the block diagram and perform the various calculations. In step A, linear testing, the power incident upon our amplifier was -10 dBm. The goal here is to determine the various settings in order to once again achieve -10 dBm at the amplifier input.

There are various “power” values in the PNA. Table 2 and the accompanying notes examine these values and explain their relationship to the hardware settings.

Table 2. PNA power level settings

	A	B	C	D
Port	Port power before source-power cal (actual PNA source power)	Cal power (power incident upon DUT)	Offset (in source-power cal menu)	Source attenuator setting
1	-42 dBm	-10 dBm	+32 dB	20 (Auto)
2	0 dBm	-22 dBm	-22 dB	0 (Auto)

Table 2 notes

Column A note: If you do not have any external components between the SOURCE OUT and CPLR THRU jumper, the port power at the source and the test port is the same. However, in this case, we have a pre-amplifier and we are coupling the boosted power back into the PNA. Consequently, the PNA source power and the port power differ by the pre-amplifier gain minus the coupler through arm loss. Before you perform a sourcepower calibration, the *test port power* value displayed in the **Channel > Power...** dialog box is the actual source power of the PNA, available either at the test port or the SOURCE OUT jumper. The range of this value is the available power from the PNA. After you perform a source-power cal, the power level on the **Channel > Power...** dialog box is now the power level at the test port of DUT input. Thus, it represents the test power port in the new condition. This value can have a wide range and depends on what external components you have connected. It can be less than the PNA source power (if you have attenuators, such as in the port 2 case), or it can be more, if you have a pre-amplifier (such as in the port 1 case).

Column B note: This is the power level you expect at the test port after the pre-amplifier and attenuator effects are calculated. The PNA will attempt to set the power at the test port to this value.

Column C note: The offset value you enter in the calibration dialog box is dependent on the components you have between the PNA and your DUT. In the case of port 1, it is 32 dB, which is the gain of the pre-amplifier minus the loss of cables. In the case of port 2, it is -22 dB, which is the loss of the external attenuator and coupler coupling factor.

Next, set the receiver attenuators. In this example, we will use 10 dB of attenuation on the B receiver.

The final step is to set the network analyzer to use the amplified reference channel signal (if your PNA has Option 081¹, reference receiver switch). Set the reference channel switch to use the external input.

Menu item **Channel > Test Set ...**

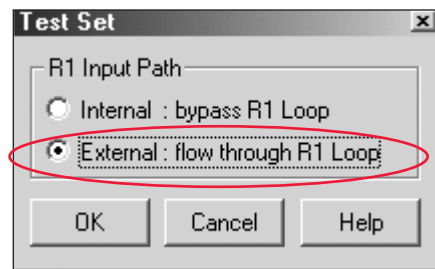

1. Option 081, External Reference Switch, is used primarily for mixer and converter measurements and is not required for amplifier measurements. However, if your analyzer is equipped with Option 081, you need to set the position of the external reference switch.

Calibration

We will perform two calibrations. One, a source-power calibration, to ensure a stable power level at the input point of the DUT (port 1) and output of the DUT (port 2 power for reverse direction measurements). Second, a full two-port calibration using ECal to remove systematic errors such as directivity, source and load match. In the source-power cal dialog box, set the offset level to the appropriate value (see Table 2 for the appropriate values). Make sure you select the **appropriate port** in source-power cal menu. The pre-amplifier should be on during this measurement.

Look for the *Src Pwr Cal* indicator on the status bar of the PNA in both the forward and reverse directions. Set the measurement to S_{21} and look for the *Src Pwr Cal* indicator. Then set the measurement to S_{12} and look for the *Src Pwr Cal* indicator.

Note

Source power calibration sets up a 'hidden' channel to perform a calibration. This channel starts with the nominal power level, which could be higher than the user's channel power level. Connect the power sensor to the setup after the firmware has asked you for the connection. Do not connect it earlier, as you could damage the power sensor with high-power.

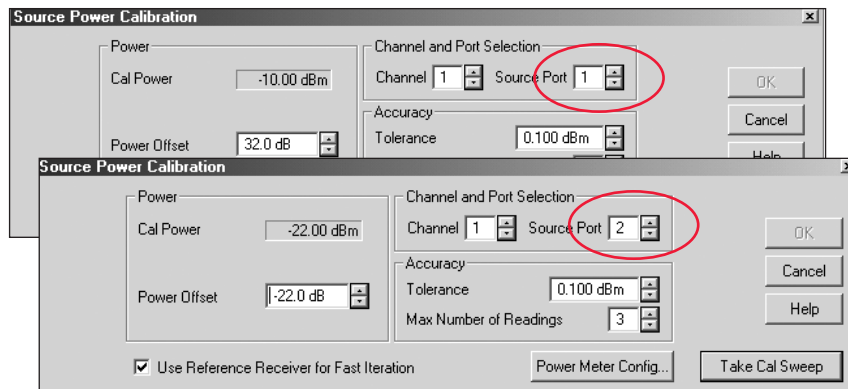

Next use an ECal module to perform a two-port cal. Connect the ECal module where the DUT would be connected. You will have to unselect the *Do Orientation* dialog box for the ECal module, to bypass the automatic orientation.

Note

If you get the error message "Electronic Cal: Unable to orient ECal module. Please ensure the module is connected to the necessary measurement ports." unselect "Do orientation." The ECal module requires -18 dBm for orientation (not calibration, but orientation), and since we have 26 dB of loss on the output port, the ECal module cannot determine its orientation. Thus, the user needs to indicate the orientation of the ECal module to the analyzer.

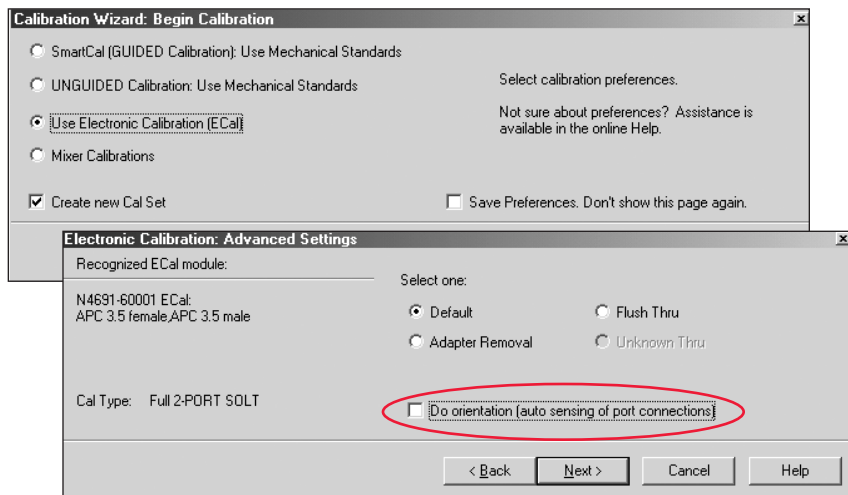

Once the calibration is performed, connect the amplifier under test and measure the S-parameters. Figure 9 shows the S-parameter measurements with and without the pre-amplifier, but with same power level incident upon the DUT. Figure 10 shows the difference between the two sets.

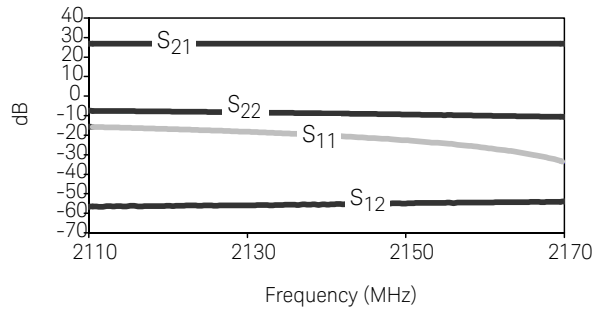

Figure 9. DUT S-parameters, with and without pre-amplifier

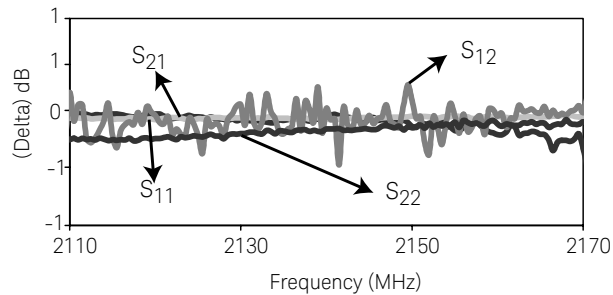

Figure 10. Difference in S-parameters, when tested with and without pre-amplifier

As you can see, the difference is very small, as expected. In addition to trace noise and measurement repeatability, the differences can be attributed to the degradation in directivity on port 2 (in the case of the pre-amplifier) and hence degradation in the two port calibration. The S_{12} measurement is closer to the noise level, so there is some level of uncertainty associated with the noise in the system. This noise level can be decreased by reduction of the IF bandwidth of the PNA.

If you are performing a similar comparison, be sure to use high-quality cables, adapters, and attenuators. Poor quality components can cause a significant amount of variation in measurements.

The optimum setup for measuring low-power S-parameters is the initial setup without the pre-amplifier and extra attenuators. If users wanted to test both low and high-power with the same setup, then they could use the high-power setup and reduce the input power levels.

Step C: Gain compression test, high-power setup

For a gain compression test, we test the amplifier under a power sweep condition. We need to determine which source attenuator setting we want to use, because we cannot switch attenuator settings through the test and maintain a valid calibration. If one attenuator setting does not cover the required range of test, then use multiple channels, using single sweeps. Multiple channels cannot have multiple attenuator settings in continuous sweep, as this would result in the switch wearing out quickly.

The power sweep ranges for the various network analyzers can be found in the specifications section of the online help system.

Note

To access the online help system available within the PNA, press the dark green Help hard key, or use the Help menu item. You can also find the help system at: <http://www.keysight.com/find/pna> > Specific product page, such as the E8364B > Library > Manuals & Guides > Online Help.

The power sweep range or PNA automatic level control (ALC) range is very dependent on the frequency range. The network analyzer used in this example has the following ALC range at 2140 MHz.

Attenuator setting	Minimum power at source	Maximum power at source
0	-27 dBm	+7 dBm
10	-37 dBm	-3 dBm
20	-47 dBm	-13 dBm

Since we have a pre-amplifier, with 20 dB attenuator settings, we can achieve a range of -10 to +18 dBm at the device. The various power levels are shown in the block diagram in

Figure 11.

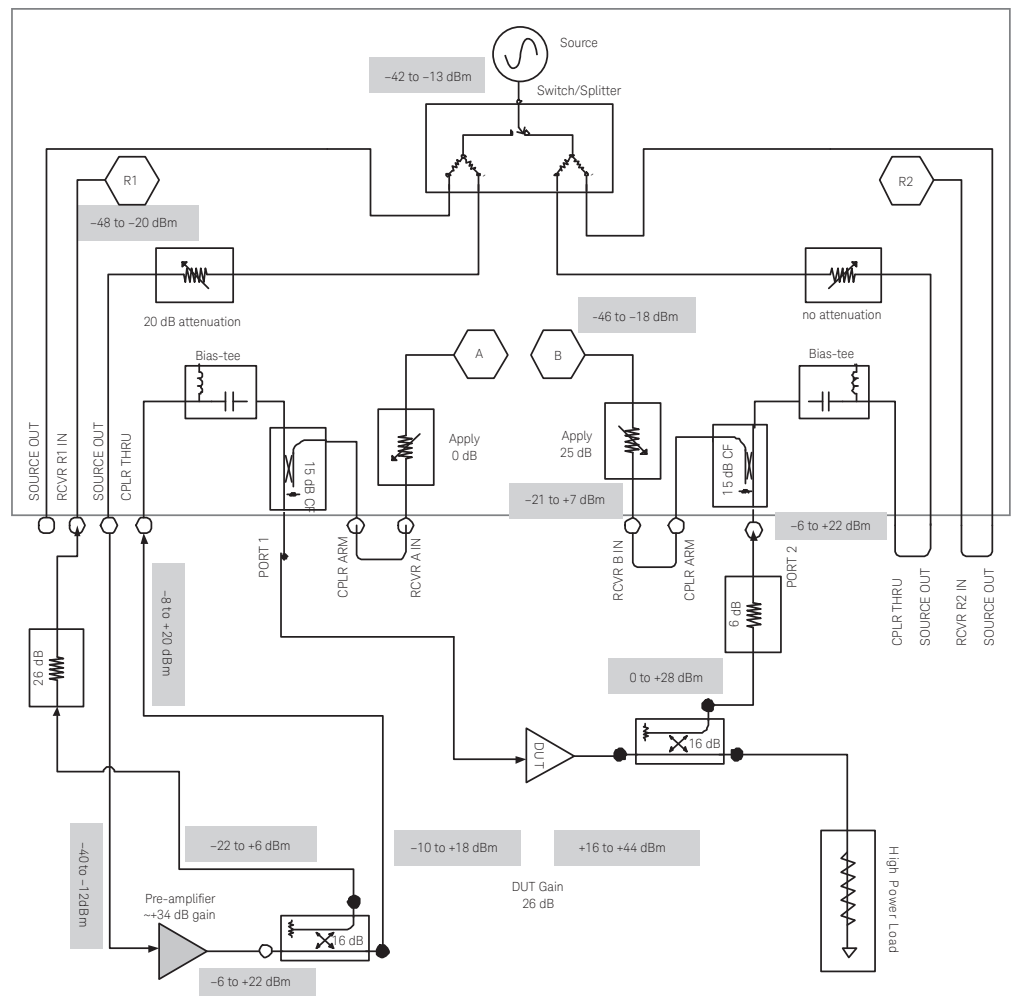

Figure 11. A power sweep for gain compression test.

Procedure for gain compression test

- [Preset]
- [Sweep Type] > Power Sweep
- [Start/Center] > CW Freq > 2140 MHz
- [Sweep Setup] > Bandwidth > 1 kHz
- [Sweep Setup] > Number of Points > 201
- [Measure] > S_{21}
- [Power] > Start Power > -42 dBm
- [Power] > Stop Power > -13 dBm



Turn on frequency-offset mode

The MW PNAs go through an automatic gain setting algorithm, when performing a power sweep. This algorithm can possibly create spurs, so we recommend users enable the frequency-offset mode, which bypasses this algorithm. Also, use the frequency-offset mode to eliminate the need for phase-locking through the external R channel.

Menu item **Channel > Frequency-offset ...** > Select “**Frequency Offset on/off**” check box
Leave the offset at 0, multiplier and division at 1

Menu item **Channel > Power...** > Set the **B receiver** attenuator to 25 dB attenuation
Menu item **Channel > Test Set > Use External reference** (If PNA has Option 081)

Perform a source-power calibration at the DUT input point.

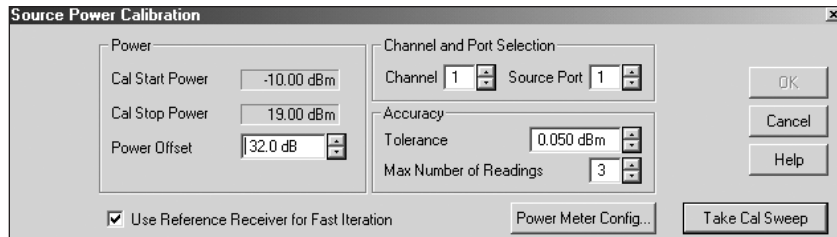

Next we perform a response calibration for the S_{21} measurement. For the absolute B receiver measurement, we perform a source and receiver calibration. The gain compression of the amplifier under test is shown in Figure 12

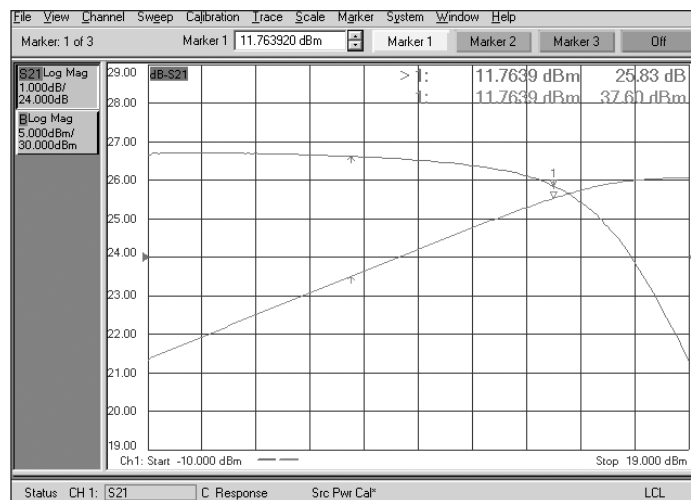

Figure 12. Amplifier gain compression

Alternative High-Power Configurations

The block diagrams below show two alternative methods of making high-power measurements.

Use of an external coupler

A high-power external coupler can be used instead of the internal coupler. It is important to select a coupler with good directivity, to ensure measurement stability after calibration.

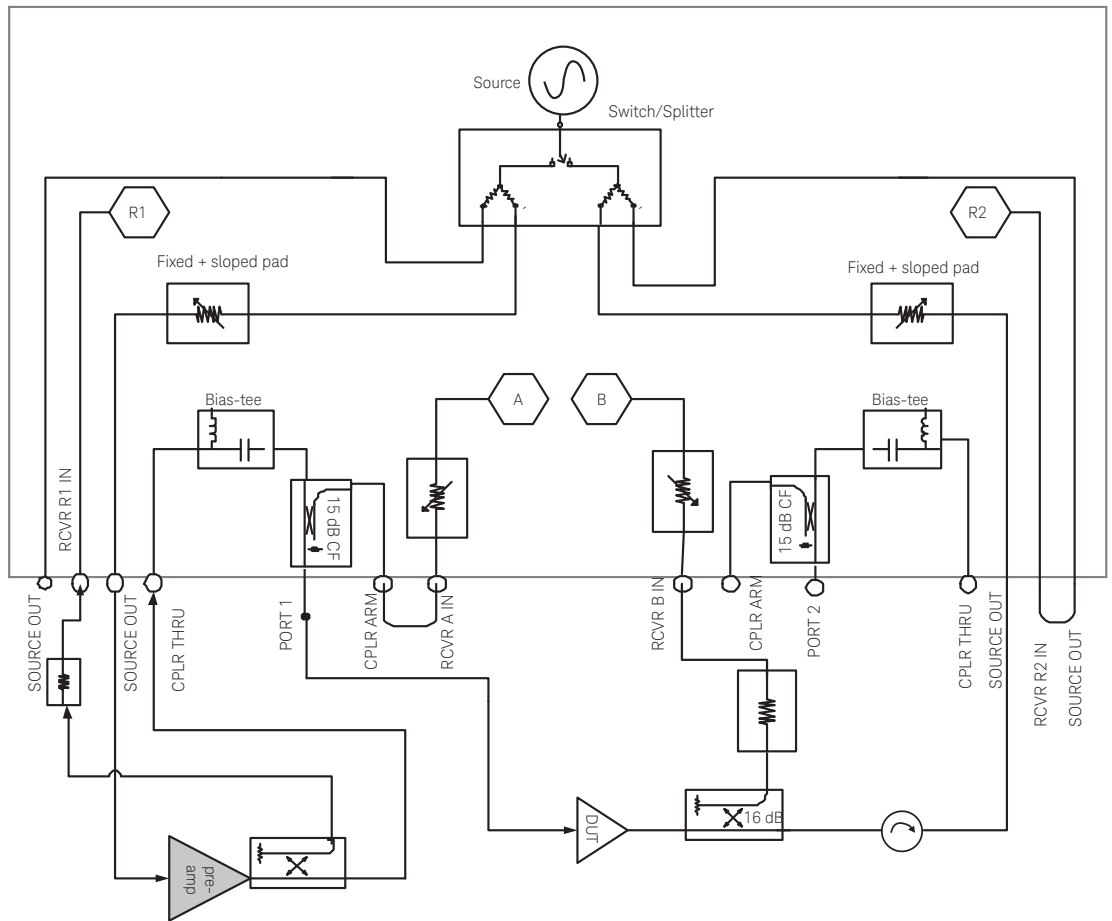

Figure 13. Use of external coupler in high-power measurements

Two-way high-power measurements

For two-way high-power measurements, a pre-amplifier needs to be added to each port. An isolator after each amplifier helps improve load match, as amplifiers usually have poor S_{22} . The isolator also protects the pre-amp from high-power on the output.

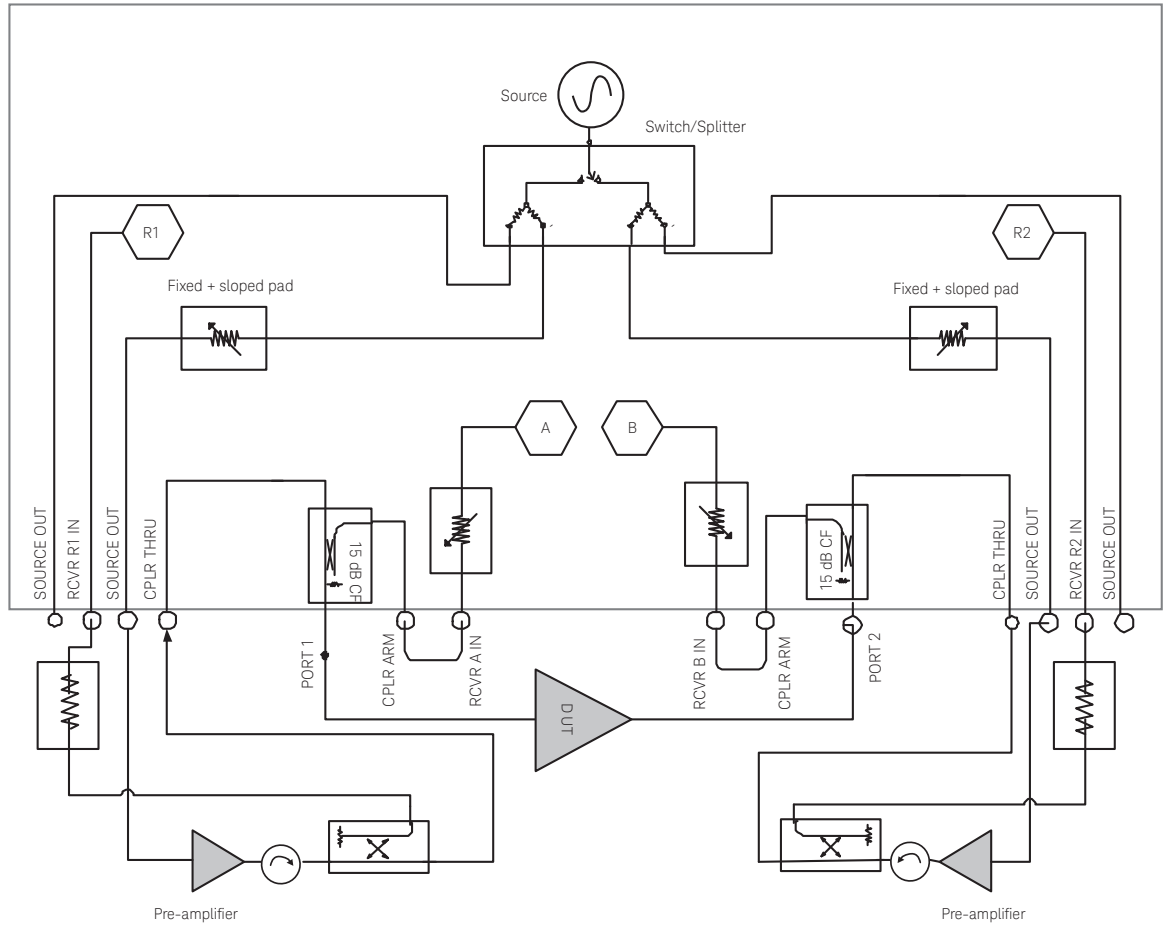

Figure 14. Two-way high-power measurements

Frequently Asked Questions

1. How do I know if the network analyzer receivers are compressed?

When testing active devices, especially amplifiers, users should pay attention to the output power levels of their devices and the power incident upon the network analyzer's receivers. Using the receivers in compression can make it difficult to differentiate between device compression and test system error. The procedure below describes a method to determine whether the internal network analyzer receivers are compressed or not. This procedure requires that the network analyzer be equipped with receiver attenuators. On the MW PNA analyzers, receiver attenuators are available with Option 016. Receiver attenuators are not available for the lower cost MW PNA-L models.

Connect your test device between ports 1 and 2 and set up an S_{21} and B channel measurement. Then change the receiver attenuator settings and examine the S_{21} and B. If the receivers are not compressed, the traces should only vary by the amount of attenuation, and not have other variations. If the receivers are compressed, you will see change other than the exact amount of attenuation. You can make the comparisons without calibration. Just make sure calibration is off in all cases. Markers can be helpful to determine if the values have decreased by the attenuation amount.

Repeat this test for the R channel receiver also, since S_{21} and AM-PM are both ratioed measurements and thus both receivers need to be tested. In an intermodulation distortion measurement, you can make the same attenuation change, but monitor the difference between the fundamental tone and the mixing products (the dBc values). If the dBc values change with attenuator setting, you can suspect that the PNA receivers are compressed.

If the test shows that the network analyzer receivers are compressed with the original settings, increase the receiver attenuation levels until the point that the receivers are no longer compressed.

On the MW PNA, the receiver attenuators can be controlled from the **Channel > Power** menu.

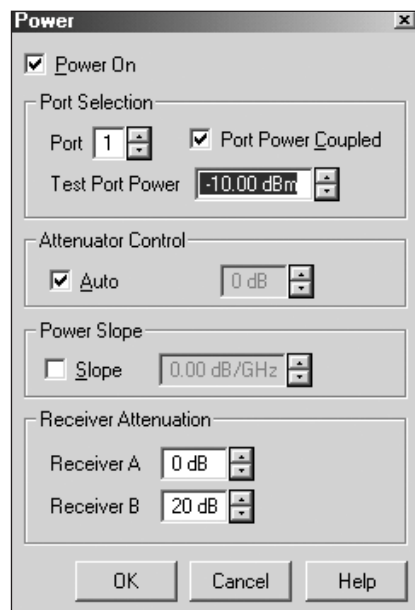

2. The uncalibrated results seem reasonable, but the calibrated data appears incorrect. What could be the cause?

A two-port calibration calculation is based on all four S-parameters. One possible issue in high-power measurements is that the S_{12} measurement could have high uncertainty due to noise, if the port powers are not uncoupled. When measuring high-gain amplifiers, it is recommended that you take advantage of the *Port Power Coupled* feature to uncouple the power of ports 1 and 2. Drive the input or port 1 with a low power level as to not damage the output receivers. Drive the output or port 2 with a high power level, so the isolation or S_{12} measurement does not approach the noise floor of the network analyzer. An accurate S_{12} measurement is fundamental to an accurate 2-port calibration.

3. What is the power of the network analyzer at start-up or preset?

At preset, the source power level of the MW PNA port 1 is set to a nominal level (see Table 3), with the internal source attenuator on port 1 set to 0 dB. The port 2 power is off. On the PNA analyzers, only one port is on at a time. If the amplifier under test could be damaged by this power level, or will be operating in its nonlinear region, do not connect the amplifier until you have set a desirable power level. On the MW PNAs, you can save a “user preset” with different initial power setting conditions. Upon preset, the MW PNA starts with the new power levels.

Table 3. Nominal power levels (Preset power level at port 1)

Network analyzer	Standard	Option 014, UNL or 014 & UNL together
E8362B (20 GHz)	0 dBm	-5 dBm
E8363B and E8364B (40 and 50 GHz)	-12 dBm	-17 dBm

4. What is the power level of different measurement channels at preset?

Each channel is initiated with the nominal power level, even if a *User Preset* is saved with a different power level for the starting channel. Therefore, if you save channel 1 with a nominal power level of -60 dBm as a *User Preset*, then start channel 2, channel 2 will start with the nominal power level (-17 dBm for an option loaded E8364B). Be careful if you set up a new channel. You could damage the components, if you did not anticipate the high power levels.

If you had *RF power Off* at the *User Preset* level for channel 1 and then you started a channel 2, then RF power would be off on channel 2 also. RF Power is a *global parameter*, versus the power level setting, which is a *channel parameter*.

5. Can different measurement channels have different power levels?

Yes. Different PNA measurement channels can have different power levels. If you set up two channels with different enough power levels resulting in different attenuator settings, the PNA will automatically put one channel in *trigger hold* mode. This is to protect the attenuators from switching continuously.

6. Can I use this setup to make hot S_{22} measurements?

If the amplifier under test is operating in its nonlinear region, the large signal S_{22} should be measured using a load-pull technique. Traditional S-parameter measurements depend on the amplifier operating in its linear region. The PNA can be used for hot S_{22} measurements; however, additional equipment and setup is required. Consult your Keysight sales representative for additional information..

7. What happens to the power level when RF power is turned off during a sweep?

The power level is turned off at the end of the sweep, so the sweep will continue with *RF power on*. The next sweep will start with *RF power off*.

8. Is there a power limitation on the mechanical components of a calibration kit?

The open or short standards do not have a power limitation, as they do not dissipate significant energy. Most Keysight calibration kit loads have a maximum average power rating of 2 Watts or +33 dBm.

9. Is there a power limitation on electronic calibration or ECal?

The maximum power rating for ECal modules is either +10 or +20 dBm (see Table below). The ECal module also has a minimum power requirement for auto-orientation (not calibration, but orientation). If the power level at the module is less than -18 dBm, the user has to tell the analyzer the orientation of the ECal module. Simply unselect the automatic orientation check box and manually indicate to the analyzer how the ECal module is connected. Auto-orientation means that the network analyzer determines how port 1 and 2 are connected to ports A and B of the ECal module.

ECal model	Minimum power	Maximum RF power	Maximum DC voltage at test port
N469x (MW ECal)	No minimum power for calibration. See paragraph above for minimum power level for auto-orientation.	+10 dBm	±10 Volts
8509x (RF ECal)		+20 dBm	±20 Volts

10. What are the benefits of a source-power calibration?

A source-power calibration transfers the accuracy of the power meter measurement to the network analyzer. The output power of the network analyzer is accurate to within 2-3 dB. For the MW PNAs, the specifications are listed in the table below. A power meter calibration can provide accuracy of better than 0.5 dB.

MW PNA power level accuracy specification

Variation from nominal power in range 0 (step attenuator at 0 dB setting)

Frequency range	Standard	Option 014	Option UNL	Option 014 & UNL
10 MHz to 45 MHz	±2 dB			
45 MHz to 10 GHz	±1.5 dB			
10 to 20 GHz	±2 dB			
20 to 40 GHz	±3 dB			
40 to 45 GHz	±3 dB	±3.5 dB	±3 dB	±3.5 dB
45 to 50 GHz	±3 dB	±4 dB	±3 dB	±4 dB

In a linear S-parameter measurement, where the amplifier is operating well within the linear range, 2-3 dB of power variation may not make a significant difference. But if you are testing and specifying gain compression and trying to find the 1 dB compression point, 2-3 dB is a significant difference and source-power calibration is necessary. Another instance where it is critical to perform a source-power calibration is in the case of high-power measurements, where a pre-amplifier is used.

Also, a source power calibration is necessary prior to a receiver calibration (in order to establish the reference). Receiver calibrations are useful for absolute power measurements.

11. What is the optimum power level for calibration?

In general, a calibration should be performed under the same stimulus/response conditions as the measurement. Thus calibrating at one power level (without amplifier) and then measuring at a different power level (with amplifier) is not ideal. However, the dynamic accuracy of the MW PNA products is extremely good, so that calibrating at a different power level does not pose a significant error (See chart for frequencies less than 20 GHz). The choice the user does have is to stay within the same power range (same attenuator setting), but to calibrate at a higher power level (without the amplifier) and then reduce the power level during the measurement (with the amplifier). Since the hardware setting is essentially the same, the accuracy is hardly affected. It is always better to calibrate at a higher power level (staying below compression), to reduce the uncertainty due to noise.

Magnitude*

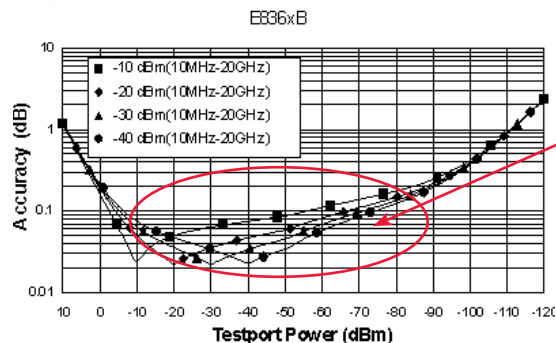

For best measurement accuracy, select the measurement and calibration power levels such that the test setup power levels remain in the relatively flat region.

12. What happens to the power level at each port during various measurements?

Parameter	Port 1	Port 2	Notes
S_{11}	On	Off	±10 Volts
S_{21}	On	Off	±20 Volts
S_{22}	Off	On	
S_{12}	Off	On	
Any parameter with two port cal; S_{11} , S_{21} , S_{12} or S_{22}	On/Off	On/Off	Power switches between the two ports, as a two-port cal requires all four S-parameters.
RF power off	Off	Off	RF power is a global parameter and is turned off for all ports and channels.

13. What happens to the two-port calibration if the source or receiver attenuation is changed?

The calibration is invalidated if you change the attenuator settings. If you change attenuator settings after you have performed a calibration, you must perform another calibration.

14. What does the error message “source unlevelled” signify?

An *unlevelled* error message appears when the source power is set to value greater than the maximum specified power. Lower the power level to solve this problem. The unlevel message is combined with a *LVL* indication on the status bar. The *unlevelled* error message can momentarily appear between attenuator settings. It does not affect the measurement accuracy and can be ignored.

15. What happens to the PNA output power during re-trace?

The power level is maintained during re-trace, unless a frequency band is crossed. See the next question for frequency-band crossings.

16. What happens to the RF power during frequency band-crossings?

The MW PNAs have over twenty frequency bands. During band-crossings, the firmware turns off the RF power. Beware that if you are testing a high-gain device with ALC, when the PNA switches bands, the power shuts down and the DUT's ALC attempts to increase the gain. Microseconds later, the PNA power comes back on; however, in this short time frame, the DUT or the PNA can get damaged. The band-crossings are listed below.

Model	Band	Frequency range (GHz)	Watts to dBm reference table	
			Linear (watts)	Log (dBm)
E8362/3/4B	0	0-0.045		
	1	0.045-0.748	0.001	+ 0
	2	0.748-1.5	0.01	+ 10
	3	1.5-3	0.1	+ 20
	4	3-3.8	1	+ 30
	5	4-4.5	2	+ 33
	6	4.5-4.8	10	+ 40
	7	4.8-6.0	20	+ 43
	8	6.0-6.4	40	+ 46
	9	6.4-7.6	50	+ 47
	10	7.6-10	100	+ 50
	11	10-12	200	+ 53
	12	12-12.8		
	13	12.8-15.2		
	14	15.2-16		
E8363/4B	15	16-20		
	16	20-22.8		
	17	22.8-25.6		
	18	25.6-30		
	19	30-32		
	20	32-36		
	21	36-38.4		
	22	38.4-40		
E8364B	23	40-45.6		
	24	45.6-48		
	25	48-50		

Appendix A: Maximum Power Levels for PNA and PNA-L Network Analyzers

Table 1 contains power level information for PNA and PNA-L network analyzers. The recommended network analyzers for high-power measurements are the PNA network analyzers E8362/3/4B Option H85. These network analyzers can handle the highest power levels and have built-in receiver attenuators. Lower cost alternatives for high-power measurements are the PNA-L products.

The next pages show block diagrams of the various network analyzers, with the power levels shown on the diagrams. The front panel layouts, which also show the damage levels, are shown after that.

In addition to the PNA network analyzers listed in Table 1, Keysight offers a high-power test set, model number Z5623AK64. The Z5623AK64 is a high-power multiport test set that can be used with the 4-port 20 GHz PNA-L, N5230A option 245.¹ The Z5623AK64 can be configured in several ways. The test set bypass configuration allows the user to use the PNA in its normal mode. In the high-power mode, the test set can be configured for specific application needs by the insertion of high-power amplifiers, attenuators, isolators, and other signal conditioning accessories. This will allow high-power measurements at RF levels up to +43 dBm (20 Watts) from 10 MHz to 20 GHz. For more information on the Z5623AK64, contact your local Keysight sales engineer.

1. At the time of the publication of this application note, the Z5623AK64 only works with the 4-port 20 GHz PNA-L, N5230A option 245. It does not work with other PNA or PNA-L products.

Table 1. PNA and PNA-L Power Level Information

To ensure that the components are not damaged, keep the power level at least 3 dB below damage level.																
Model family	Max freq.	Model	Test set	Signal separation device ¹	Bias tees ²	Rcvr attns ³	Coupler/bridge loss	Ideal power at receiver ⁴	Port 1, 2, 3 or 4	Coupler arm	Receiver A, B, C, D, R1, or R2 in	Port 1, 2, 3, 4 source out	Coupler thru	Reference source out	Option 081 ref switch	Damage Level
PNA	20 GHz	E8362B	Standard or with Option UNL ⁵	Couplers	Yes	Yes	13-15 dB	-20 dBm	+30 dBm	+30 dBm	+15 dBm	+30 dBm	+30 dBm	+20 dBm	+30 dBm	+30 dBm
PNA	40 GHz	E8363B		Couplers	Yes	Yes	13-15 dB	-20 dBm	+30 dBm	+30 dBm	+15 dBm	+30 dBm	+30 dBm	+20 dBm	+30 dBm	+30 dBm
PNA	50 GHz	E8364B		Couplers	Yes	Yes	13-15 dB	-20 dBm	+30 dBm	+30 dBm	+15 dBm	+30 dBm	+30 dBm	+20 dBm	+30 dBm	+30 dBm
PNA	20 GHz	E8362B#H85	Option 014, or Option H85 (but not UNL) ⁶	Couplers	No	Yes	13-15 dB	-20 dBm	+30 dBm ⁷	+30 dBm ⁷	+15 dBm	+30 dBm	+30 dBm ⁷	+20 dBm	+30 dBm	+30 dBm
PNA	40 GHz	E8363B#H85		Couplers	No	Yes	13-15 dB	-20 dBm	+30 dBm ⁷	+30 dBm ⁷	+15 dBm	+30 dBm	+30 dBm ⁷	+20 dBm	+30 dBm	+30 dBm
PNA	50 GHz	E8364B#H85		Couplers	No	Yes	13-15 dB	-20 dBm	+30 dBm ⁷	+30 dBm ⁷	+15 dBm	+30 dBm	+30 dBm ⁷	+20 dBm	+30 dBm	+30 dBm
PNA	67 GHz	E8361A	Configurable	Couplers	Yes	Yes	11-15 dB	-25 dBm	+27 dBm	+30 dBm	+15 dBm	+27 dBm	+27 dBm	+20 dBm	+270 dBm	+270 dBm
PNA-L	6 GHz	N52300-020	Standard	Bridges	No	No	15-16 dB	-10 dBm	+27 dBm ⁸							
PNA-L	13.5 GHz	N52300-120	Standard	Bridges	No	No	15-16 dB	-10 dBm	+27 dBm ⁸							
PNA-L	20 GHz	N52300-240	Standard 4-port	Bridges	No	No	15-16 dB	-10 dBm	+27 dBm ⁸							
PNA-L	20 GHz	N52300-220	Standard	Couplers	No	No	13-15 dB	-10 dBm	+30 dBm							
PNA-L	40 GHz	N52300-420	Standard	Couplers	No	No	13-15 dB	-25 dBm	+30 dBm							
PNA-L	50 GHz	N52300-520	Standard	Couplers	No	No	13-15 dB	-25 dBm	+30 dBm							
PNA-L	6 GHz	N52300-025	Configurable ⁹	Bridges	No	No	15-16 dB	-10 dBm	+27 dBm ¹⁰	+15 dBm ¹¹	+15 dBm	+27 dBm	+27 dBm ¹⁰	+20 dBm		
PNA-L	13.5 GHz	N52300-125	Configurable	Bridges	No	No	15-16 dB	-10 dBm	+27 dBm ¹⁰	+15 dBm ¹¹	+15 dBm	+27 dBm	+27 dBm ¹⁰	+20 dBm		
PNA-L	20 GHz	N52300-245	Configurable, 4-port	Bridges	No	No	15-16 dB	-10 dBm	+27 dBm ¹⁰	+15 dBm ¹¹	+15 dBm	+27 dBm	+27 dBm ¹⁰	+20 dBm		
PNA-L	20 GHz	N52300-225	Configurable	Couplers	No	No	13-15 dB	-10 dBm	+30 dBm ⁷	+15 dBm ⁷	+30 dBm	+30 dBm	+30 dBm ⁷	+20 dBm		
PNA-L	40 GHz	N52300-425	Configurable	Couplers	No	No	13-15 dB	-25 dBm	+30 dBm ⁷	+15 dBm ⁷	+30 dBm	+30 dBm	+30 dBm ⁷	+20 dBm		
PNA-L	50 GHz	N52300-525	Configurable	Couplers	No	No	13-15 dB	-25 dBm	+30 dBm ⁷	+15 dBm ⁷	+30 dBm	+30 dBm	+30 dBm ⁷	+20 dBm		

¹On coupler based-products the damage levels of the coupled arm and the thru arms are the same. On bridge-based products, the damage levels of the "coupled arm" and the "thru arm" are different

²Bias-tees are supplied with Option UNL. Option UNL includes two 60 dB source-attenuators and two bias-tees. Option UNL is available for the PNA Series, but not the PNA-L.

³Receiver attenuators are supplied with Option 016. Two 35 dB receiver attenuators supplied. Option 016 is available for the PNA Series, but not the PNA-L.

⁴The "ideal power level at receiver" listed in this table is a power level at which the receiver is not compressed. The power level shown is the most conservative value (highest frequency, maximum loss). Often you can have a higher incident power and still not be in compression. To calculate a less conservative value, subtract the 0.1 dB compression level (available in the Help System) from the coupler or bridge loss to obtain the max recommended power level.

⁵The specifications in this row apply to any standard E8362/3/4B, or any E8362/3/4B that is configured with option UNL, the bias-tee and source attenuator option. If the bias-tee option is included, the bias-tees is located directly behind the coupler. Therefore, there is no way to reduce the power before the bias-tees, so the maximum power is limited to +30 dBm, the damage level of bias-tees. The bias-tees are the power limiting factor.

⁶The specifications in this row apply to any E8362/3/4B that is configured with Option 014, the configurable test set option, and is not configured with option UNL, the bias-tee option. These specifications apply to the #H85 high power test set. The #H85 option includes options 014 (configurable test set), 016 (receiver attenuators), 080 (frequency offset mode), 081 (reference receiver switch), and source attenuators. Since bias-tees are not part of these analyzers attenuators can be added after the couplers and before the switch/splitter and receiver attenuators, so that the user can take advantage of the high-power handling capability of the couplers.

⁷The specification for maximum damage level is +30 dBm, but the front-end couplers can handle up to +43 dBm <20 GHz and +40 dBm >20 GHz. Just be sure to protect the other components with isolators or attenuators.

⁸Damage level of the switch/splitter assembly is +27 dBm. Without a configurable test set, the user cannot add attenuation in path of the switch/splitter and the damage level is +27 dBm.

⁹With configurable test set, the user can take advantage of the high-power handling capability of the bridges. The user has to add attenuation after the bridge to protect the switch/splitter assembly and the receivers.

¹⁰The damage level specification is +27 dBm, but the front-end bridges can handle up to +33 dBm. Just be sure to protect the other components with isolators or attenuators.

¹¹The damage level specification is +15 dBm, but the coupler (bridge) arm can handle up to +18 dBm. Just be sure to protect the other components with isolators or attenuators.

Front panel of PNA and PNA-L network analyzers (damage levels listed on front panels)

E8362/3/4B

N5230A
Opt 220/420/520

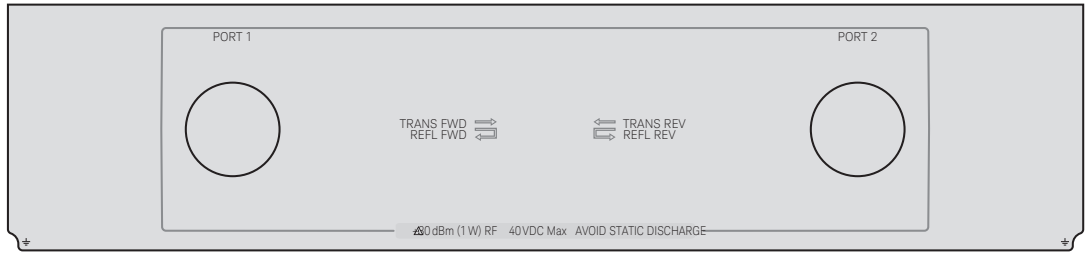

E8362/3/4B

Opt 014
N5230A
Opt 225/425/525

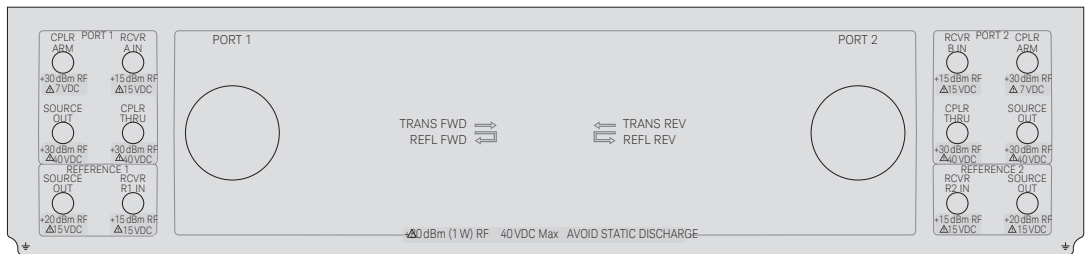

N5230A
Opt 220/120

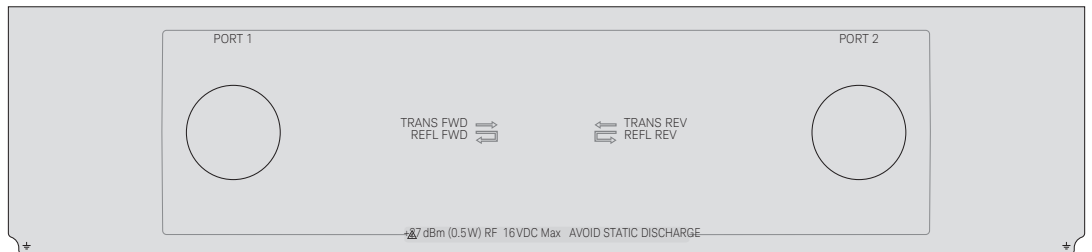

N5230A
Opt 240

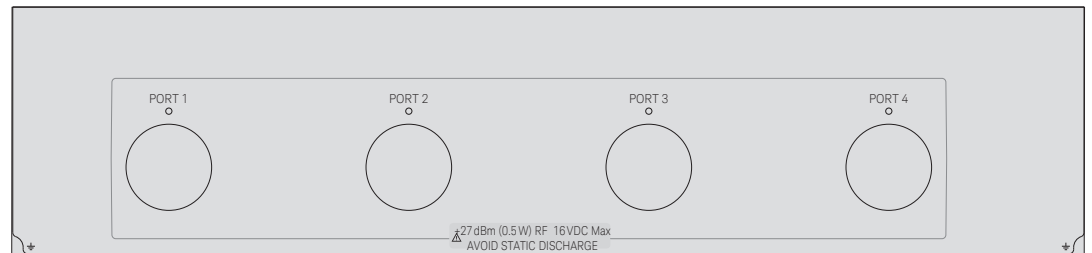

N5230A
Opt 025/125

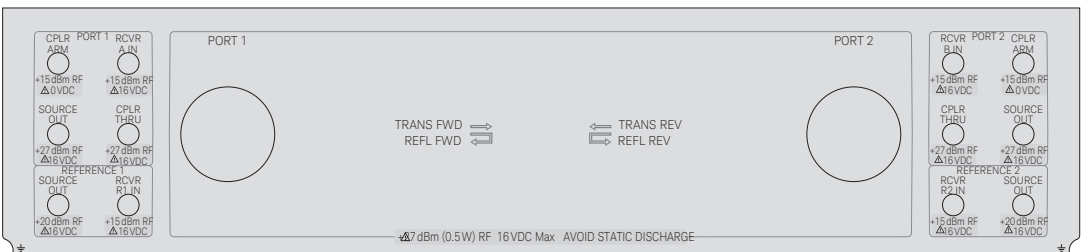

N5230A
Opt 245

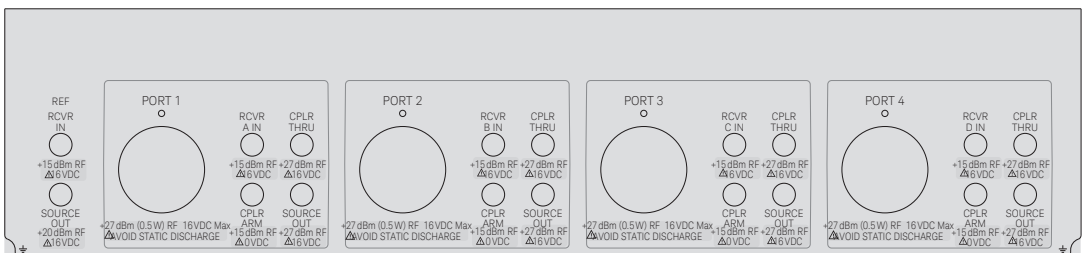

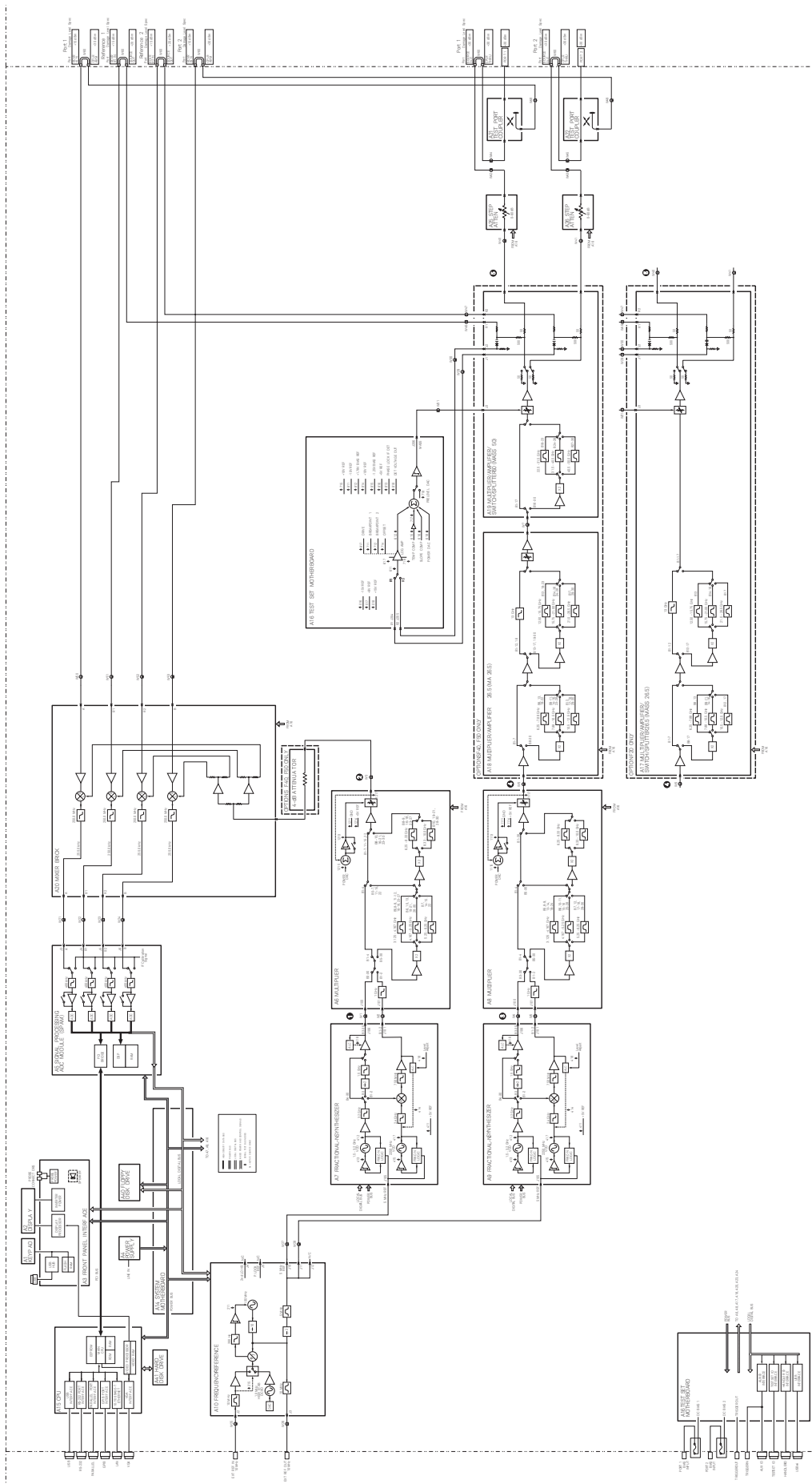

Figure 3. 20/40/50 GHz PNA-L - N5230A with options 225/425/525

Appendix B: Understanding PNA measurements with an external reference signal and source attenuator changes

Note

In this section, we are discussing source attenuators. We specifically refer to them as source attenuators, to differentiate them from receiver attenuators, which are also available on PNA products.

This section describes the PNA behavior when an external reference signal is used in conjunction with source attenuator changes. An external reference signal may be used to amplify the PNA signal, if high power levels are needed. We examine the S-parameter and reference receiver measurements in detail, using an example.

Figure 1 shows an E8362/3/4B PNA network analyzer. The network analyzer shown includes the following options:

- Option 014: Configurable test set (adds the front panel loops or jumpers)
- Option UNL: Two 60 dB source attenuators and two bias-tees
- Option 016: Two 35 dB receiver attenuators
- Option 080: Frequency-offset mode (no unique hardware shown in diagram, but Opt 080 does have unique hardware)
- Option 081: Reference receiver switch

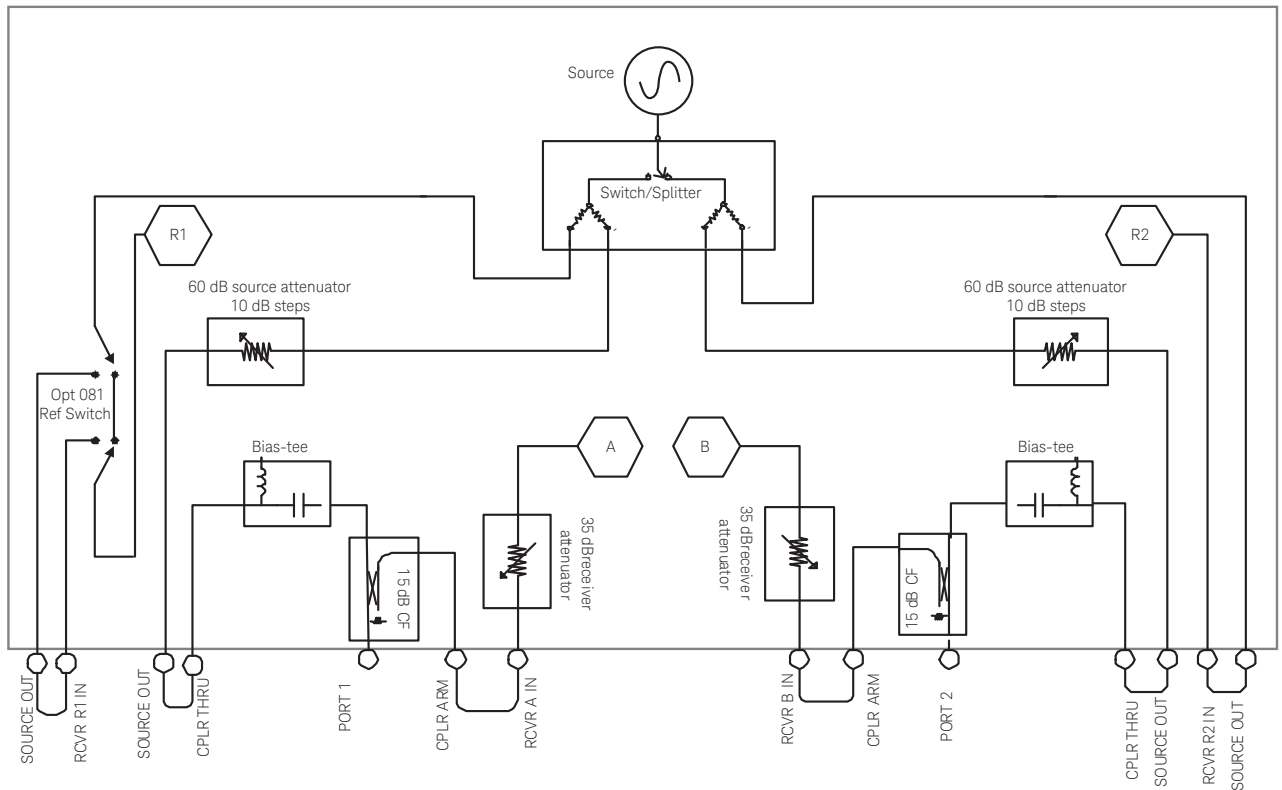

Figure 1. PNA (E8362/3/4B) block diagram for basic measurements

The purpose of this section is to describe the PNA behavior as the source attenuator is varied. For this measurement scenario, we focus on the relevant terms, which are source power level, source attenuator setting, S-parameter, and receiver measurements. The stimulus parameters of frequency range, IF bandwidth and number of points are not relevant.

Note
 $S_{11} = A/R_1$

Let's examine a basic measurement scenario using the configuration shown in Figure 1. We will make a simple uncalibrated S_{11} measurement of an open, by leaving test port 1 open. We set up three traces to measure S_{11} , A and R_1 , as shown in Figure 2.

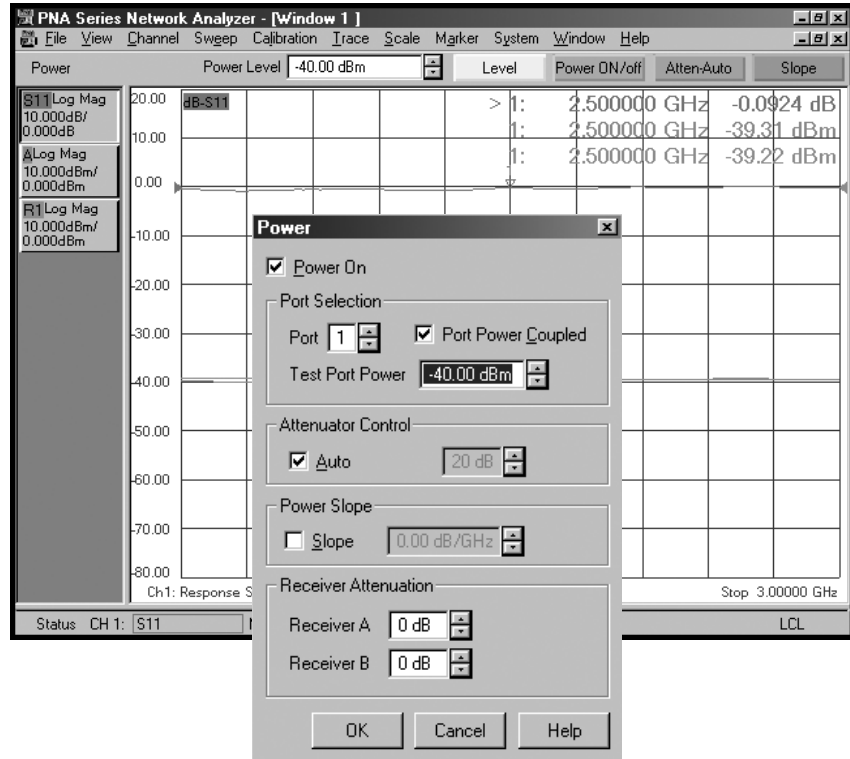

Figure 2. Case A, -40 dBm power level, 20 dB source attenuator

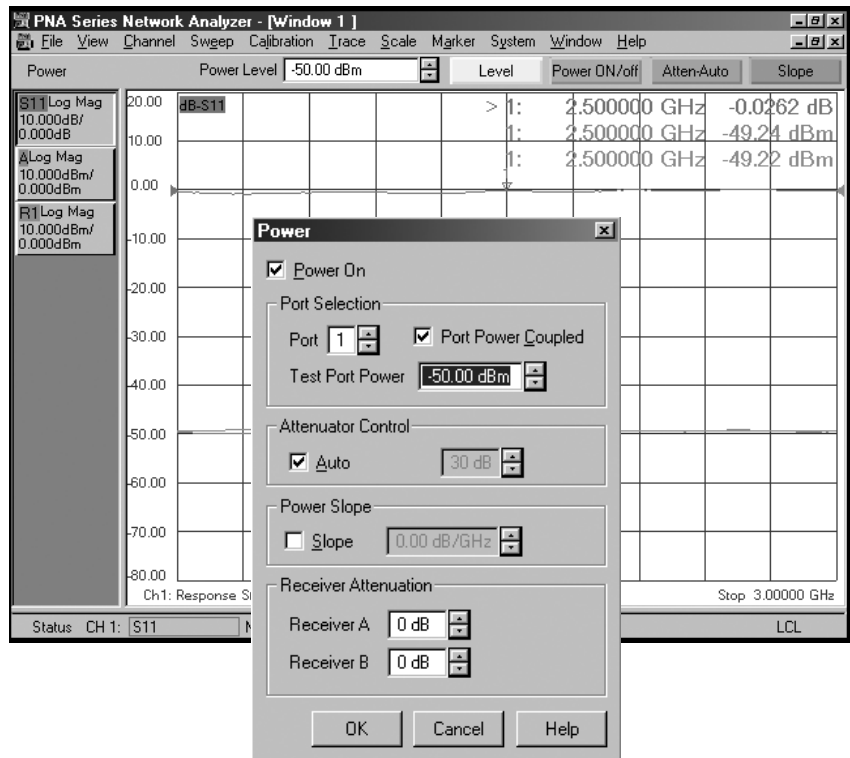

Figure 3. Case B, -50 dBm power level, 30 dB source attenuator

Note

After examining the block diagram, you may observe that due to the coupling factor of the coupler (which is 15 dB), the A receiver value should be 15 dB lower than the R1 receiver value, with the source attenuator set to 0 dB. However, based on measurements and data shown in Table 1, you can see that the A and R1 receivers display the same value. The reason for this is a factory calibration called “mixer cal”. “Mixer cal” is the result of a set of calibrations performed at the factory on every network analyzer. Each PNA network analyzer has a series of files on the hard drive in the C:\Program Files\Keysight\Network Analyzer\ directory, that have the prefix “mxcalfile_”. These files contain the “mixer cal” data and are unique to each network analyzer. “Mixer cal” corrects for coupler losses, cable losses, differences between receivers, and more. The data from “mixer cal” is applied to all measurements, so that if users do not perform calibrations such as one-port or two-port, their measured data is reasonable.

For our first measurement, we set the power level to –40 dBm (Case A in Table 1).

Table 1.

Case	PNA power level (dBm)	Source attenuator setting (auto) (dB)	S_{11} (dB)	A displayed on analyzer (dBm)	R1 displayed on analyzer (dBm)	R1 incident upon receiver ¹ (dBm)
A	–40	20	–0.09	–39.31	–39.22	–19.0
B	–50	30	–0.02	49.24	–49.22	–19.0
C	–60	40	–0.05	–59.06	–59.01	–19.0

If the power is set to –40 dBm, the source attenuator setting will be 20 dB (See Figure 2). The three traces will measure –0.09 dB for S_{11} , –39.31 dBm for A, and –39.22 dBm for R1. These are the expected values, as the power level was set to –40 dBm, the test port was left open, and so all the signal was reflected back. The reference receiver value displayed on the PNA is –40 dBm approximately (–39.22 dBm), and the A receiver saw all the power reflected back (approximately all the –40 dBm or –39.31 dBm in this case).

Now let’s drop the power by 10 dB to –50 dBm (Case B, Table 1). We would expect the S_{11} value not to change, as the S_{11} of an open, a linear device, should not change significantly with power variation, and in fact, the S_{11} does not change. The S_{11} value is still about the same, –0.02 dB. Let’s look at the A and R1 values. They both drop by the expected 10 dB drop in power. The A receiver measurement value drops from –39.31 to –49.24 dBm, and the R1 value drops from –39.22 to –49.22 dBm. This is reasonable. Now take a close look at the block diagram in Figure 1, specifically at the location of the 60 dB source attenuator. Notice how the source attenuator is in the path of the main signal that is directed to port 1, but not in the path of the reference receiver R1. So if we change the source attenuator value (as we did from case A to case B), we would expect the R1 receiver value to not change. From case A to case B, the power level at the PNA synthesized source itself did not change, but the source attenuator changed from 20 to 30 dB. So purely based on the block diagram, the R1 receiver value should have stayed constant from case A to case B. But we see from Table 1 that it did in fact change by 10 dB. So the question is, why did the R1 value not stay constant, as expected by the block diagram?

The reason for the change in the R1 value is that in the PNA firmware we have an adjustment factor for the R1 receiver value that corresponds to the attenuation amount. We will call this the “attenuation adjustment factor”. If you compare case A to case B, the actual power incident upon the R1 reference receiver was the same in both cases, but the firmware displayed a lower value for case B, compared to case A. You can observe the same behavior if you go to case C, where the attenuation is increased to 40 dB.

The reason for this “attenuation adjustment factor” is that we want PNA users to receive reasonable values for their uncalibrated measurements. In the example above, if you are a PNA user, from case A to case B, you do not expect the S_{11} value to change. You are measuring an open and simply varying the power level. For a linear device, such as an open, the S_{11} value should approximately stay the same. If the PNA firmware did not add the “attenuation adjustment factor”, the S_{11} value would have changed by 10 dB (from case A to case B). That can be confusing to users. Hence the “attenuation adjustment factor” is used in the PNA firmware.

1. These are approximate values for the power incident upon the R1 reference receiver. They are calculated based on the displayed R1 value, minus the source attenuation factor.

If you are making *uncalibrated* high-power measurements, using an *external reference signal*, and you are *changing the source attenuator settings*, there is a consequence to using this adjustment factor. The measurement results will not be as you expect. This behavior is discussed next.

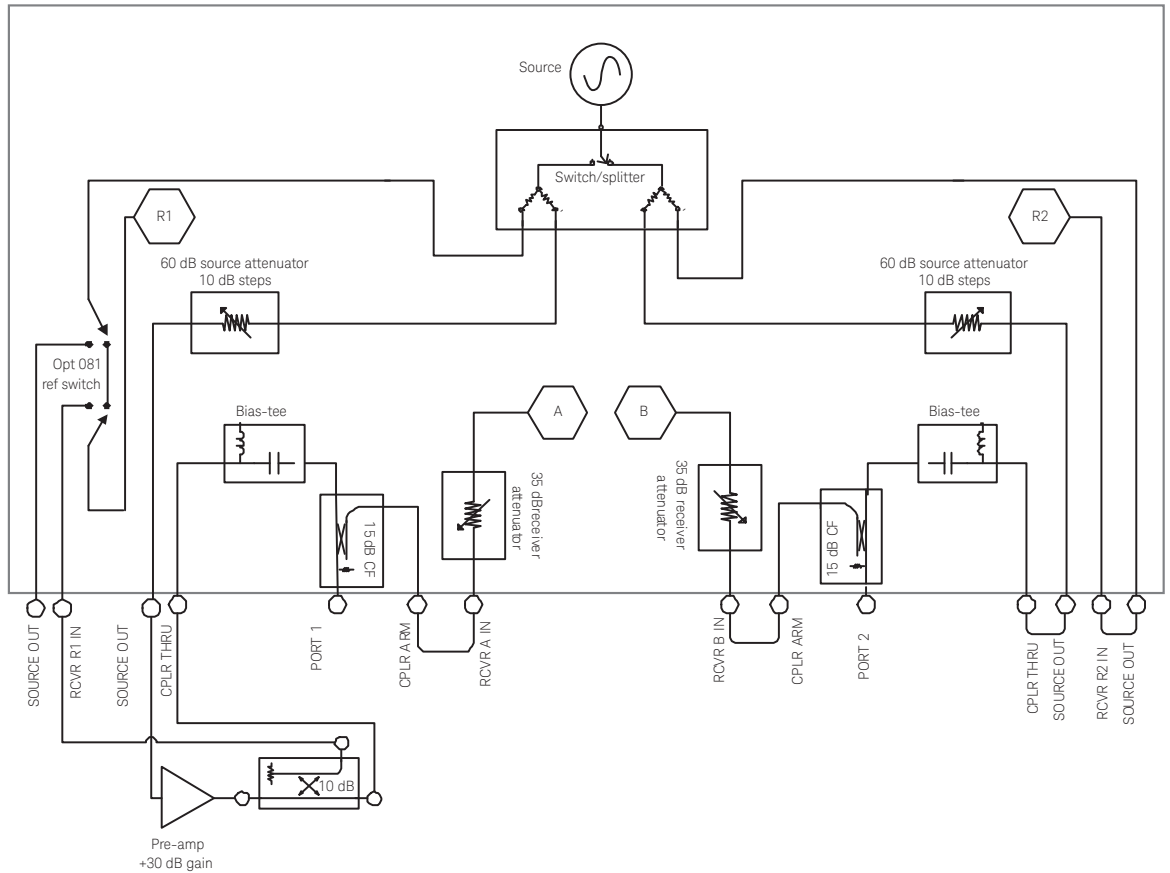

Figure 4. High-power setup connection diagram

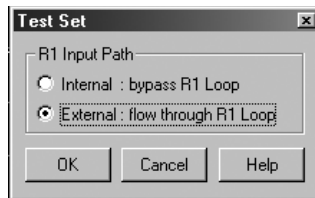

Figure 5. Use of external test set mode for high-power measurements

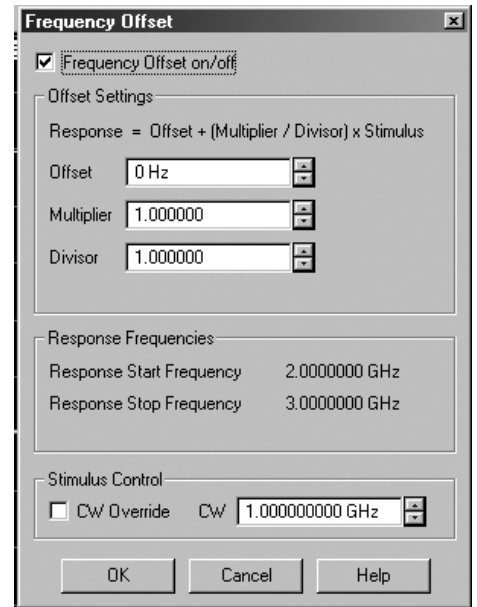

Figure 6. Use frequency-offset mode to take advantage of independent phase-locking circuitry

With this setup, we have approximately 20 dB of gain in the R1 path, and 30 dB of gain in the A receiver path. We start the measurement with a source power of -40 dBm. Due to the gains in the A and R1 paths, the A value is now -10.9 dBm and the R1 value is -20.4 dBm, giving us an S_{11} of 9.5 dB (See Table 2). If we decrease the power level by 10 dB to -50 dBm (case B, Table 2), we expect S_{11} to remain the same. Since again, the S_{11} of an open should not really change with power level variations¹. However, we notice that the S_{11} changes to 19.5 dB. Furthermore, if we decrease the power another 10 dB to -60 dBm (case C, Table 2), the S_{11} value changes to 29.5 dB. We know that this change in S_{11} is incorrect. So how do we explain this behavior?

Table 2.

Case	PNA power level (dBm)	Source attenuator setting (auto) (dB)	S_{11} (dB)	A displayed on analyzer (dBm)	R1 displayed on analyzer ² (dBm)	R1 incident upon receiver (dBm)
A	-40	20	9.5	-10.9	-20.4	-0.4
B	-50	30	19.5	-20.9	-40.4	-10.4
C	-60	40	29.5	-30.9	-60.4	-20.4

1. Assume the external pre-amplifier is operating in its linear region.
2. The value of the receiver power level is not exactly what you expect from the block diagram. Other components in the path (not shown here) affect the power level. The absolute values in external test set mode are not accurate without a calibration. The point of the data in Table 2 is the relative difference between cases A, B and C, not the absolute values.

This behavior is easily understood now that we know the methodology used to calculate the R1 value. In case A, the source is set to -40 dBm. There is 30 dB of gain in the port 1 path, so it makes sense that the A receiver values is -10.9 dBm. With 20 dB of gain in the R1 receiver path, we get -20.4 dBm in the R1 path. Now if we change the power level to -50 dBm (case B, Table 2), the A receiver value drops by 10 dB from -10.9 dBm to -20.9 dBm. This is as expected. However, if we look at R1, we see a 20 dB change in the R1 value, for a 10 dB change in the source attenuator setting.

Note

This behavior (the difference between external R1 input and internal R1 input, with uncalibrated measurements) will not be observed on network analyzers where the source attenuator is located before the switch/splitter. In such cases, both the A and R1 receivers see the same power level, as the source attenuation is applied to both measurements. So there is no “attenuation adjustment factor” applied to the reference receiver values.

The PNA architecture of placing the source attenuator in the A receiver path provides more accuracy (compared to the case where the attenuator is in both the A and R1 path) because the reference receiver power level can be maintained at an optimum level, with a very good signal to noise ratio. For example, if you are measuring a high-gain device and want a low input power level, the reference receiver will still see a high power level and the measurement will not be noisy.

Additionally, in standard measurement mode¹, the reference receiver is used for phase-locking purposes². So a strong signal is required at the reference receiver. PNA's phase locking technique allows the PNA to make very fast measurements with very low trace noise. The superb combination of speed and trace noise is one of the key differentiators of the PNA family of network analyzers.

The reason is that with the configuration shown in Figure 4, the source attenuator is in the path of the R1 receiver. In the standard configuration, shown in Figure 1, the source attenuator is not in the path of the R1 receiver. So the “attenuation adjustment factor” does not apply to this measurement scenario (Figure 4), but it is still applied by the firmware. The R1 receiver sees the 10 dB drop in power, and also gets an additional attenuation adjustment factor of 10 dB, for a total of 20 dB of drop. This explains why the R1 value is incorrect and hence the S_{11} value is incorrect.

The conclusion is that if you are making S-parameter measurements using an external reference signal and are also changing the source attenuator setting, you need to calibrate the setup for each attenuator setting. Calibration will remove the above errors. If you are making gain compression measurements, you can experiment with setting the source attenuator to manual mode, in order to determine the optimal power range for your measurements. The PNA Help System contains the latest specifications for the power ranges.

1. Not frequency-offset mode
2. Applicable to PNA Series analyzers and not applicable PNA-L Series.

Example of optimal power range for a power sweep or gain compression measurement

We use an example to demonstrate how you can select the optimal power range for a gain compression measurement. Let's say you wanted to measure a 12 GHz device with approximately -30 dBm, and you have a 50 GHz E8364B network analyzer. You look up the power range specifications of the E8364B (listed in Table 3).

Table 3. E8364B power range specifications

Frequency Range	Power Range	ALC Range
10 MHz to 45 MHz	-87 to $+2$ dBm	29 dB
45 MHz to 10 GHz	-87 to $+3$ dBm	30 dB
10 to 20 GHz	-87 to 0 dBm	27 dB
20 to 30 GHz	-87 to -4 dBm	23 dB
30 to 40 GHz	-87 to -8 dBm	19 dB
40 to 45 GHz	-87 to -11 dBm	16 dB
45 GHz to 50 GHz	-87 to -17 dBm	10 dB

So based on the specifications, the analyzer has a 27 dB ALC or power sweep range. You set up a power sweep and make power measurements on your network analyzer. Table 4 has an example of what you may see.

Table 4. Power ranges for a sample 50 GHz PNA, an E8364B

Range #	Attenuation (dB)	Default power range min (dBm)	Default power range max (dBm)	Manual attenuation min (dBm)	Manual attenuation min (dBm)
0	0	-27	2	-27	2
1	10	-37	-28	-37	-8
2	20	-47	-38	-47	-18
3	30	-57	-48	-57	-28
4	40	-67	-58	-67	-38
5	50	-77	-68	-77	-48
6	60	-87	-78	-87	-58

In this case, with the default setting, you would use 10 dB of attenuation and a range of -37 to -28 dBm (a 10 dB sweep range). If you use manual source attenuation, you can use either the 10 dB setting which covers -37 to -8 dBm (a 30 dB range), or the 20 dB setting which covers -47 to -18 dBm (another 30 dB range). You can decide which range is more applicable for your compression test. Thus for power sweep applications such as gain compression, it is a good idea to understand the various power ranges, and use the optimal one.

Recommendations for High-Power Measurements

- Use a network analyzer with a configurable test set, especially if you need to add a pre-amplifier.
- Apply receiver attenuation to keep the network analyzer receivers out of compression.
- Attenuate the output signal after the PNA coupler and before receivers. Attenuation before the PNA coupler degrades directivity.
- Increase measurement accuracy by performing a source-power calibration.
- Eliminate the need for phase-locking through external reference channel, by using PNA's frequency-offset mode.
- For power-meter measurements, use power sensors designated for high-power levels.
- Uncouple test port 1 and 2 port powers, to control forward and reverse power levels.
- Take advantage of the two independent source attenuators.

Web Resources

Visit our Web sites for additional product information and literature.

Microwave and RF network analyzers:

www.keysight.com/find/na

PNA microwave network analyzers:

www.keysight.com/find/pna

Electronic calibration (ECal):

www.keysight.com/find/ecal

Test and measurement accessories:

www.keysight.com/find/accessories



myKeysight

www.keysight.com/find/mykeysight

A personalized view into the information most relevant to you.

For more information on Keysight Technologies' products, applications or services, please contact your local Keysight office. The complete list is available at: www.keysight.com/find/contactus

Americas

Canada	(877) 894 4414
Brazil	55 11 3351 7010
Mexico	001 800 254 2440
United States	(800) 829 4444

Asia Pacific

Australia	1 800 629 485
China	800 810 0189
Hong Kong	800 938 693
India	1 800 112 929
Japan	0120 (421) 345
Korea	080 769 0800
Malaysia	1 800 888 848
Singapore	1 800 375 8100
Taiwan	0800 047 866
Other AP Countries	(65) 6375 8100

Europe & Middle East

Austria	0800 001122
Belgium	0800 58580
Finland	0800 523252
France	0805 980333
Germany	0800 6270999
Ireland	1800 832700
Israel	1 809 343051
Italy	800 599100
Luxembourg	+32 800 58580
Netherlands	0800 0233200
Russia	8800 5009286
Spain	800 000154
Sweden	0200 882255
Switzerland	0800 805353
	Opt. 1 (DE)
	Opt. 2 (FR)
	Opt. 3 (IT)
United Kingdom	0800 0260637

For other unlisted countries:
www.keysight.com/find/contactus
(BP-09-23-14)